

SUB
915

SUB
918

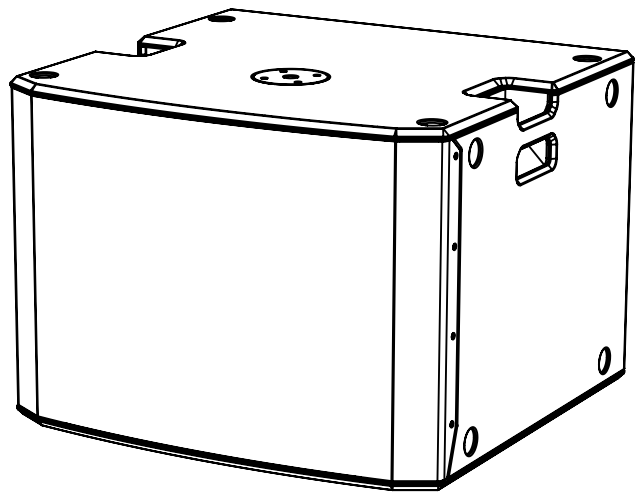
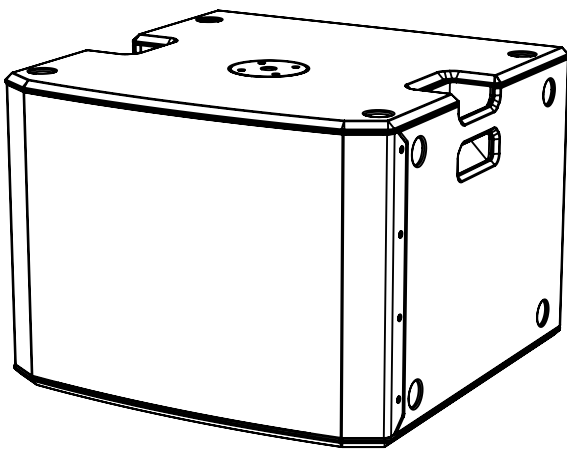

MANUALE D'USO – Sezione 1
USER MANUAL - Section 1
BEDIENUNGSANLEITUNG - Abschnitt 1
CARACTERISTIQUES TECHNIQUES - Section 1
MANUAL DEL USUARIO - Sección 1

Le avvertenze nel presente manuale devono essere osservate congiuntamente al "MANUALE D'USO - Sezione 2".
The warnings in this manual must be observed together with the "User Manual - Section 2".
Die Warnungen in diesem Handbuch müssen in Verbindung mit der "BEDIENUNGSANLEITUNG - Abschnitt 2" beobachtet werden".
Les avertissements spécifiés dans ce manuel doivent être respectés ainsi que les "CARACTERISTIQUES TECHNIQUES -Section 2".
Las advertencias del presente manual se deben tener en cuenta conjuntamente con las del "Manual del usuario" - Sección 2".

EMI CLASSIFICATION

According to the standards EN 55103 this equipment is designed and suitable to operate in E3 (or lower E2, E1) Electromagnetic environments.

FCC CLASS B STATEMENT ACCORDING TO TITLE 47, CHAPTER I, SUBCHAPTER A, PART 15, SUBPART B

This equipment has been tested and found to comply with the limits for a Class B digital device, pursuant to part 15 of the FCC Rules. These limits are designed to provide reasonable protection against harmful interference in a residential installation. This equipment generates, uses and can radiate radio frequency energy and, if not installed and used in accordance with the instructions, may cause harmful interference to radio communications. However, there is no guarantee that interference will not occur in a particular installation. If this equipment does cause harmful interference to radio or television reception, which can be determined by turning the equipment off and on, the user is encouraged to try to correct the interference by one or more of the following measures:

- Reorient or relocate the receiving antenna.
- Increase the separation between the equipment and receiver.
- Connect the equipment into an outlet on a circuit different from that to which the receiver is connected.
- Consult the dealer or an experienced radio/TV technician for help.

Changes or modifications not expressly approved by the party responsible for compliance could void the user's authority to operate the equipment.

WARNING

Make sure that the loudspeaker is securely installed in a stable position to avoid any injuries or damages to persons or properties. For safety reasons do not place one loudspeaker on top of another without proper fastening systems. Before hanging the loudspeaker check all the components for damages, deformations, missing or damaged parts that may compromise safety during installation. If you use the loudspeakers outdoor avoid spots exposed to bad weather conditions.

Contact dBTechnologies for accessories to be used with the speakers. dBTechnologies will not accept any responsibility for damages caused by inappropriate accessories or additional devices.

ITALIANO

ENGLISH

DEUTSCH

FRANÇAIS

ESPAÑOL

INDICE

1. INFORMAZIONI GENERALI	5
BENVENUTI!	5
PANORAMICA INTRODUTTIVA	5
RIFERIMENTI PER L'UTENTE.....	5
CARATTERISTICHE MECCANICHE ED ACUSTICHE	6
DIMENSIONI.....	6
CARATTERISTICHE DELLA SEZIONE DI AMPLIFICAZIONE E DI CONTROLLO	7
SEZIONE DI INPUT, OUTPUT E DI CONTROLLO	8
SEZIONE DI ALIMENTAZIONE.....	9
2. PRIMA ACCENSIONE.....	10
COLLEGAMENTO DEGLI INGRESSI E RILANCIO AUDIO.....	11
COLLEGAMENTO DELL' ALIMENTAZIONE	12
3. ESEMPI DI UTILIZZO.....	13
UTILIZZO A TERRA	13
UTILIZZO CON SPEAKER IN STACK.....	13
UTILIZZO SU SUBWOOFER CON PALO TELESCOPICO.....	13
4. RISOLUZIONE DEI PROBLEMI	14
5. SPECIFICHE TECNICHE	15
GENERALE	15
DATI ACUSTICI.....	15
AMPLIFICATORE.....	15
PROCESSORE.....	16
INTERFACCIA UTENTE.....	16
INGRESSI E USCITE	16
SPECIFICHE DI ALIMENTAZIONE (ASSORBIMENTO / INSTALLAZIONE)	16
DIMENSIONI.....	17

1. INFORMAZIONI GENERALI

BENVENUTI!

Grazie per aver acquistato un prodotto progettato e sviluppato in Italia da dBTechnologies! Questo subwoofer attivo, versatile ed ergonomico, è frutto di una lunga esperienza nel campo della diffusione sonora, con l'impiego di soluzioni ottimizzate in campo acustico ed elettronico, oltre che nella scelta dei materiali.

PANORAMICA INTRODUTTIVA

I nuovi subwoofer della serie SUB 900 sono equipaggiati rispettivamente con un woofer da 15" (SUB 915) ed un woofer da 18" (SUB 918). La precisa progettazione ed ottimizzazione acustica consente prestazioni di alta qualità in un prodotto dalle dimensioni contenute. L'elevata ergonomia e maneggevolezza dei cabinet li rendono facili da trasportare.

Le caratteristiche principali di SUB 915 e SUB 918 sono:

- un progetto ergonomico, compatto e versatile, per contesti indoor e outdoor
- cabinet in legno per ottimizzare le prestazioni acustiche, con superficie esterna resistente per utilizzo indoor e outdoor
- amplificatore digitale affidabile e silenzioso
- controlli del DSP dedicati, con selezione di Polarità, Delay, Xover, Sensitivity

RIFERIMENTI PER L'UTENTE

Per utilizzare al meglio il vostro subwoofer consigliamo di:

- leggere il manuale d'uso quick start presente nella confezione e questo manuale d'uso completo in ogni sua parte e conservarlo per tutta la durata di vita del prodotto.
- registrare il prodotto sul sito <http://www.dbtechnologies.com> nella sezione "[SUPPORTO](#)".
- conservare prova d'acquisto e GARANZIA (Manuale d'uso "sezione 2").

CARATTERISTICHE MECCANICHE ED ACUSTICHE

DIMENSIONI

Le dimensioni si SUB 915 e S918 sono:

- SUB 915: 620 x 457 x 620 (mm)
- SUB 918: 720 x 530 x 690 (mm)

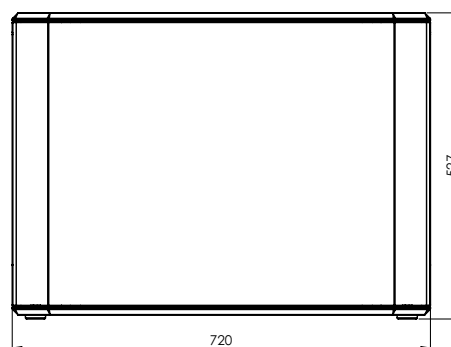
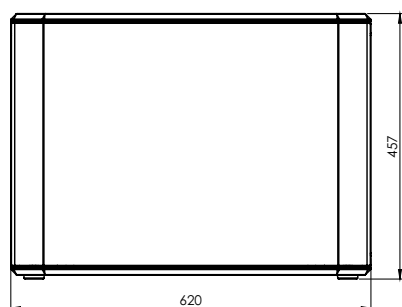
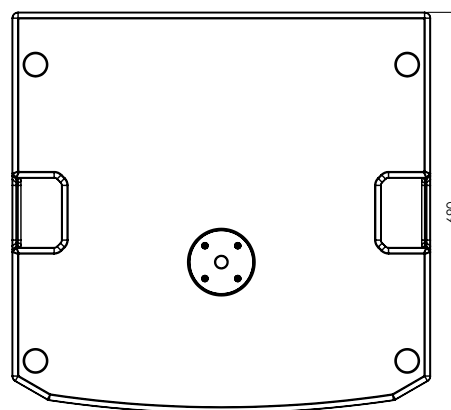
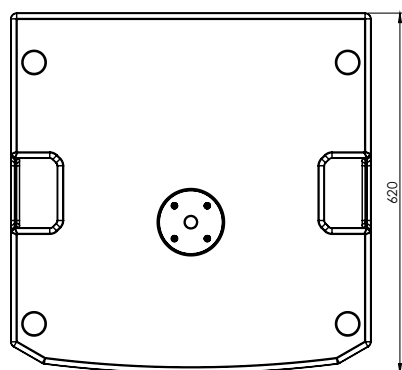

CARATTERISTICHE DELLA SEZIONE DI AMPLIFICAZIONE E DI CONTROLLO

L'amplificatore Digipro G3 è il cuore dei SUB 915 e SUB 918.

Il sistema è silenzioso ed il controllo è affidato ad un DSP dedicato che gestisce diversi parametri.

La potenza di amplificazione sonora è di 900 W RMS.

Il pannello dell'amplificatore è caratterizzato da:

- Sezione di Input, Output e Controllo
- Sezione di Alimentazione



ATTENZIONE!

- Non tentare in nessun modo di aprire l'amplificatore.
- In caso di surriscaldamento eccessivo, il volume audio viene ridotto gradualmente fino alla stabilizzazione termica del modulo. Il livello viene ristabilito automaticamente al raggiungimento della corretta temperatura di funzionamento.
- In caso di malfunzionamento, interrompere immediatamente l'alimentazione, scollegando il modulo dalla rete, e contattare un riparatore autorizzato.



ATTENZIONE!

- Non rimuovere mai la griglia frontale di protezione del prodotto. Per prevenire il pericolo di scossa elettrica, in caso di danneggiamento accidentale o sostituzione della griglia di protezione (da effettuarsi presso il servizio assistenza), disconnettere immediatamente l'alimentazione. Non connettere mai l'alimentazione di rete mentre la griglia è rimossa.

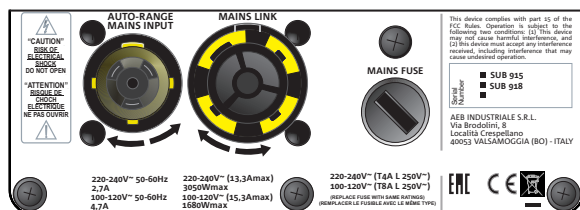
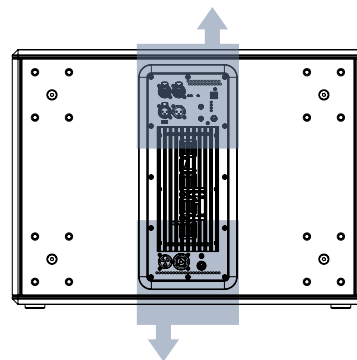
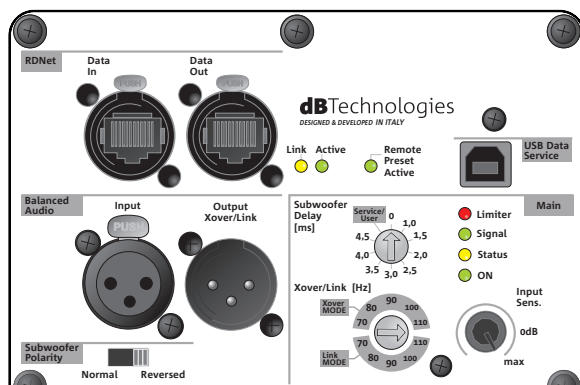

SEZIONE DI INPUT, OUTPUT E CONTROLLO

SEZIONE DI ALIMENTAZIONE

SEZIONE DI INPUT, OUTPUT E DI CONTROLLO

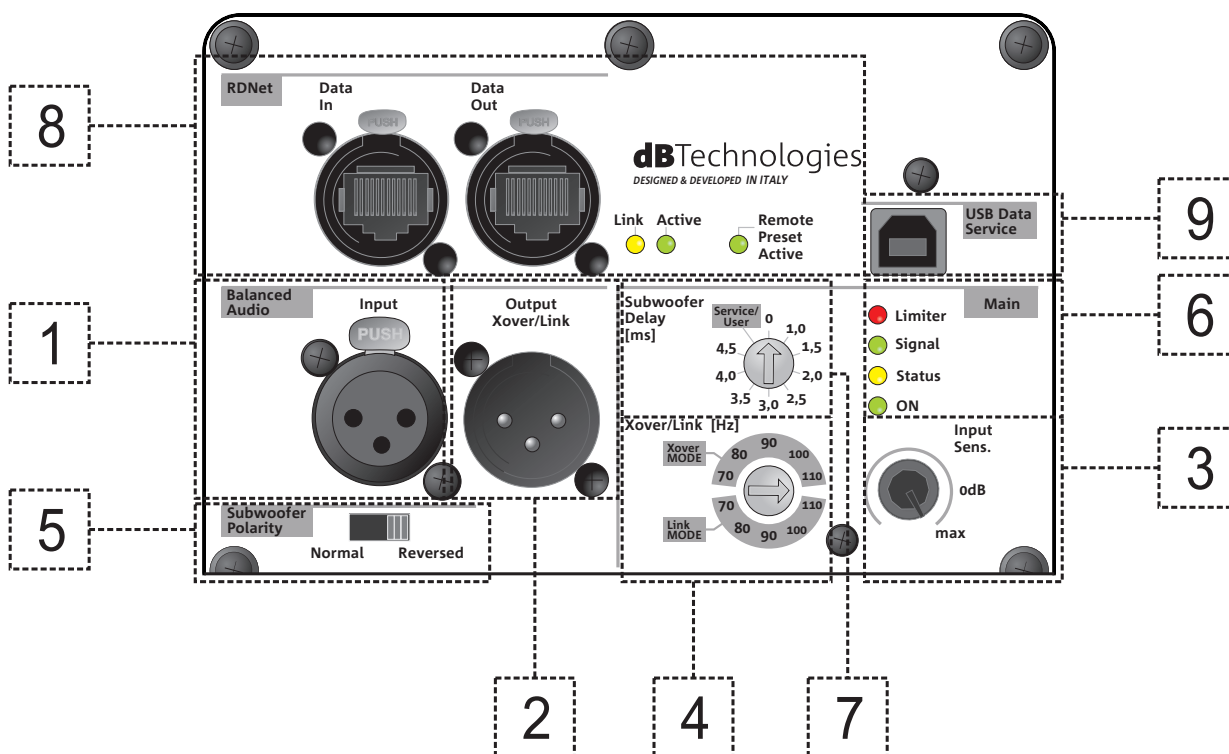

1. INPUT

Connettore dell'ingresso, di tipo XLR (bilanciato). Per i dettagli di collegamento, vedi la sezione COLLEGAMENTO DEGLI INGRESSI E RILANCIO AUDIO.

2. OUTPUT

Connettore dell'uscita, di tipo XLR (bilanciato). Selezionare la frequenza di taglio relativa alla modalità Xover/Link nel relativo rotary. Per i dettagli di collegamento, vedi la sezione COLLEGAMENTO DEGLI INGRESSI E RILANCIO AUDIO.

3. Input Sensitivity

Rotary di regolazione della sensibilità di ingresso.

4. Xover/Link rotary

Selettore che permette di impostare la frequenza di taglio a seconda della modalità prescelta (Link/Xover). Agisce sul segnale rilanciato dai connettori Output Xover/Link

5. Selettore Subwoofer Polarity

Selettore che permette di intervenire sulla Polarità (Normal o Reverse)

6. LED (Limiter, Signal/ON)

Led di segnalazione. Il led Limiter si accende qualora intervenga il circuito di protezione interna, Signal/ON rivela l'accensione del subwoofer e la presenza di segnale audio in ingresso.

SEZIONE DI ALIMENTAZIONE

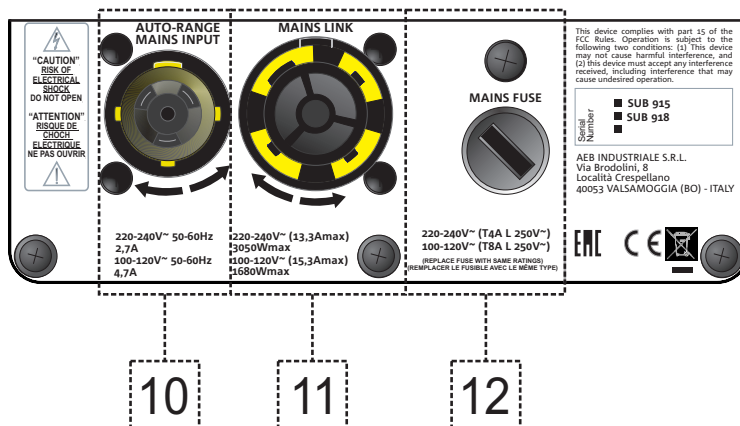

7. Subwoofer Delay

Rotary che permette di impostare il ritardo (delay) in ms.

8. Sezione RNet con LED di controllo

Sezione compatibile con cavi di rete dotati di connettori di tipo etherCON/RJ45.

In particolare "Data in" deve essere collegato a dispositivi come RNet Control 2 o Control 8, "Data Out" viene utilizzato per il rilancio della rete ad ulteriori moduli del line-array in configurazione daisy-chain.

I led relativi al funzionamento in rete (RNet) del modulo assicurano un monitoraggio real-time.

In particolare, "Link" acceso segnala che la rete RNet è attiva e ha riconosciuto il dispositivo, "Active" in modalità lampeggiante che esiste traffico dati, "Remote Preset Active" che tutti i controlli locali sul pannello amplificatore sono by-passati dal controllo remoto RNet.

9. USB Data Service

Connettore USB per l'aggiornamento firmware.

10. MAINS INPUT

Compatibile con connettore powerCON TRUE1®.

11. MAINS LINK

Compatibile con connettore tipo powerCON TRUE1® per il rilancio dell'alimentazione ad altri moduli.

Per conoscere il numero massimo di moduli che si possono connettere in un sistema rilanciato, consultare la sezione [SPECIFICHE TECNICHE](#).

12. MAINS FUSE

Alloggio per il fusibile di rete

2. PRIMA ACCENSIONE

La confezione del subwoofer SUB 915 / SUB 918 contiene:

- subwoofer 915 oppure subwoofer 918
- cavo di alimentazione POWERCON TRUE1
- quick start e documentazione cartacea relativa alla garanzia

CONFIGURAZIONE ED OTTIMIZZAZIONE

Inserito e ruotato il connettore powerCON TRUE1®, connesso all'alimentazione di rete, il subwoofer si accende.

Per ottimizzare l'utilizzo del subwoofer per alcune particolari configurazioni, l'utente ha a disposizione sul pannello di controllo:

- Xover/Link [Hz]:
 1. Link (il segnale presente alle uscite OUTPUTS è quello applicato al woofer)
 2. Xover (il segnale presente alle uscite OUTPUTS è filtrato con frequenza di crossover di 120 Hz, per il rilancio a speaker, come ad esempio B-HYPE e OPERA)
- Subwoofer Polarity:
 1. Normal (Polarità normale del segnale audio)
 2. Reverse (Polarità invertita, opzione utile per ottimizzare il fronte d'onda invertendo la fase dell'onda acustica)
- Subwoofer Delay:

E' possibile selezionare il delay applicabile per varie configurazioni, secondo quanto riportato in serigrafia.

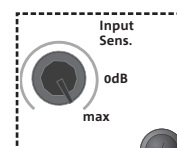
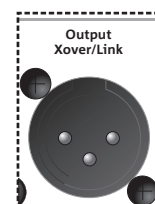
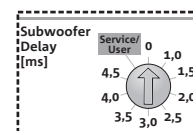
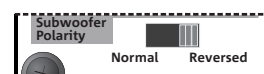
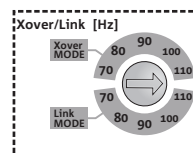

Prima dell'accensione, si consiglia di posizionare il selettore di livello Input Sensitivity su 0 dB

COLLEGAMENTO DEGLI INGRESSI E RILANCIO AUDIO

Sono riportate 2 figure di esempio a titolo puramente indicativo

In caso di collegamento tra subwoofer e speaker:

1. Collegare l'uscita del mixer al connettore di ingresso del subwoofer
2. Collegare il connettore di uscita del subwoofer all'ingresso dello speaker.
3. Posizionare OUTPUT XOVER/LINK [4] del subwoofer su XOVER, in modo da rilanciare allo speaker un segnale con frequenza di crossover selezionabile col rotary Xover/Link [Hz]

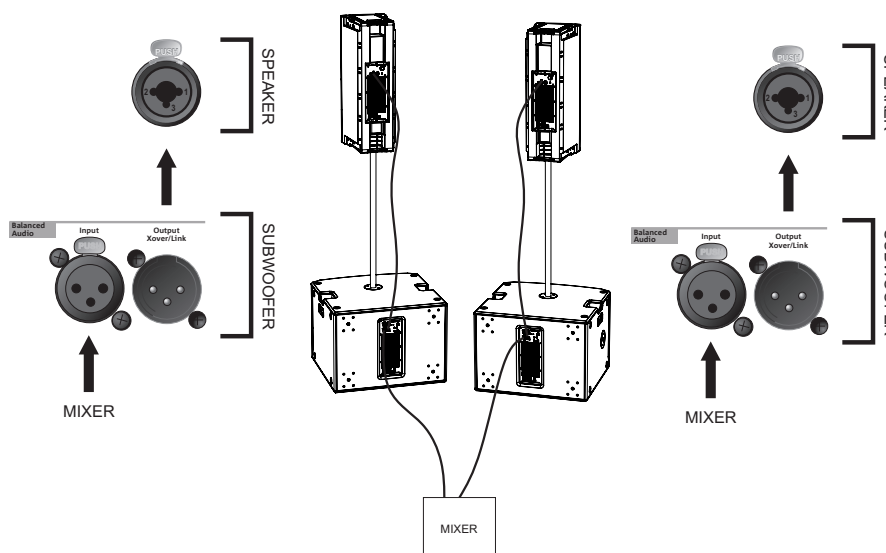
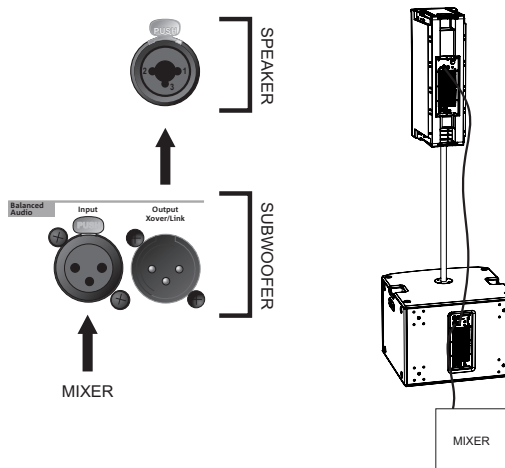

* Balanced

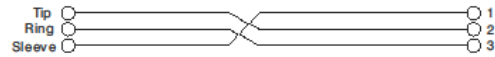
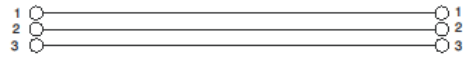
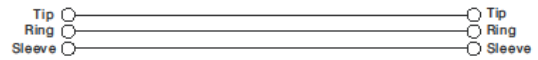
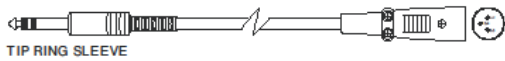
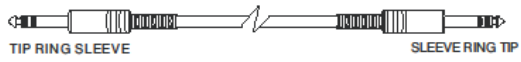

* Unbalanced

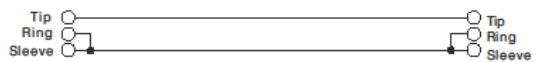
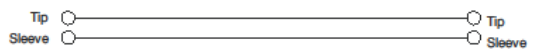
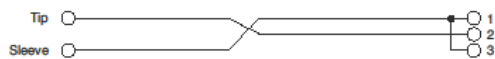
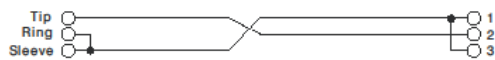
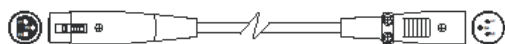
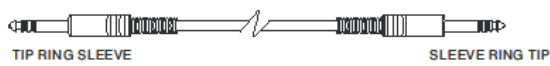
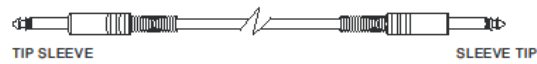
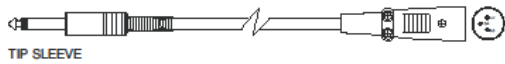
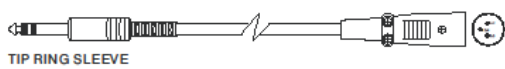

3. ESEMPI DI UTILIZZO



- Non sono ammessi tipi di installazione diversi da quelli qui illustrati.
- In nessun caso utilizzare le maniglie del subwoofer per appenderlo
- Verificare sempre che il posizionamento sia stabile, e che l'installazione non costituisca fonte di pericolo per persone, animali o cose.

UTILIZZO A TERRA

E' possibile l'utilizzo dei subwoofer 915 e 918 direttamente a terra.

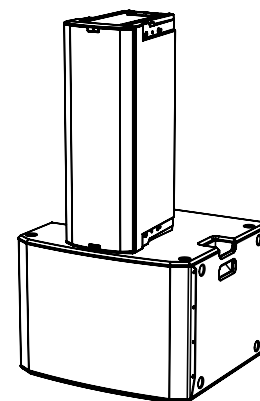

UTILIZZO CON SPEAKER IN STACK

E' possibile l'utilizzo di uno speaker montato direttamente sul subwoofer 915 o 918 tramite il mini-palo di diametro 35 mm DS2-S (es. serie: INGENIA, B-HYPE, OPERA).

E' necessario un fissaggio addizionale

UTILIZZO SU SUBWOOFER CON PALO TELESCOPICO

E' possibile l'utilizzo di un solo speaker montato su palo diametro 35 mm. L'accessorio di riferimento è DS-2 (palo telescopico).

E' necessario un fissaggio addizionale

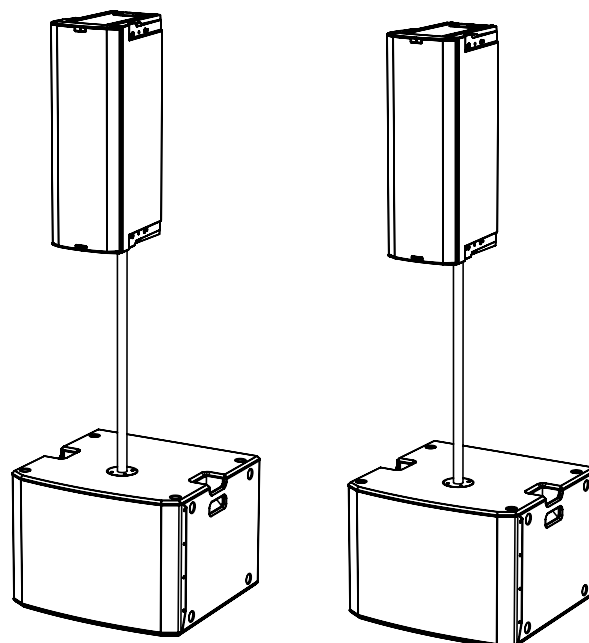

4. RISOLUZIONE DEI PROBLEMI

Il subwoofer non si accende:

1. Verificare la corretta presenza dell'alimentazione a monte dell'impianto.
2. Verificare che il cavo di alimentazione sia correttamente inserito.

Il subwoofer si accende ma non emette nessun suono:

1. Verificare che il collegamento in ingresso del segnale audio sia correttamente effettuato.
2. Verificare che i cavi utilizzati non siano danneggiati.
3. Verificare che il mixer o la sorgente audio sia accesa e mostri chiaramente la presenza di segnale in uscita.
4. Verificare il livello generale tramite il controllo "Input Sensitivity".

Il diffusore emette un suono non adeguato:

1. Verificare che i cavi utilizzati non siano danneggiati, nel qual caso sostituirli (un cavo danneggiato può portare a perdita o alterazione del segnale).
2. Verificare che le impostazioni sul pannello di controllo siano impostate correttamente.

5. SPECIFICHE TECNICHE

GENERALE

Tipologia:	Subwoofer attivo
------------	------------------

DATI ACUSTICI

Risposta in frequenza [-10dB]:	45 - Cut freq Hz (SUB 915) / 42 -Cut Freq Hz (SUB 918)
Max SPL (1m):	133 dB (SUB 915) / 134 dB (SUB 918)
LF:	15" (SUB 915) / 18" (SUB 918)
LF voice coil:	4"
Frequenza di crossover:	Variabile (70 Hz - 80 Hz - 90 Hz - 100 Hz - 110 Hz)

AMPLIFICATORE

Tipologia:	DIGIPRO G3
Classe di amplificazione	Classe D
Alimentazione	PowerCON TRUE1
Potenza di amplificazione RMS:	900 W

PROCESSORE

Controller interno:	DSP 28/56 bit
Limiter:	Peak, RMS, Termico

INTERFACCIA UTENTE

Controlli:	Delay, Xover/Link, Polarity, Sensitivity
------------	--

INGRESSI E USCITE

Ingressi:	2 x XLR Balanced Inputs
Uscite:	2x XLR Balanced Outputs

SPECIFICHE DI ALIMENTAZIONE (ASSORBIMENTO / INSTALLAZIONE)

Assorbimento a 1/8 della potenza in condizioni medie di utilizzo (*):	1,2 A (220-240V~) - 2 A (110-120V~)
Assorbimento a 1/3 della potenza in condizioni massime di utilizzo (**):	2.7 A (220-240V~) - 4.7 A (110-120V~)
Assorbimento con speaker acceso in assenza di segnale (idle):	21 W
Corrente di inrush:	21.04 A

* **NOTA PER L'INSTALLATORE:** Valori riferiti a 1/8 della potenza, in condizioni medie di funzionamento (programma musicale con clipping raro o assente). Si consiglia per qualsiasi tipo di configurazione di considerarli i valori minimi di dimensionamento.

** **NOTA PER L'INSTALLATORE:** Valori riferiti a 1/3 della potenza, in condizioni pesanti di funzionamento (programma musicale con frequente clipping e intervento del limiter). E' consigliabile il dimensionamento secondo questi valori in caso di installazioni e tour professionali.

DIMENSIONI

Materiale:	Legno multistrato (con vernice protettiva nera)
Griglia:	Lavorazione CNC
Maniglie:	2, laterali
Montaggio su palo:	Sì, 36 mm (predisposizione: M20)
Larghezza:	620 mm (SUB 915) 720 mm (SUB 918)
Altezza:	457 mm (SUB 915) 530 mm (SUB 918)
Profondità:	620 mm (SUB 915) 690 mm (SUB 918)
Peso:	34.8 kg (SUB 915) 41.8 kg (SUB 918)

Caratteristiche, specifiche e aspetto dei prodotti sono soggetti a possibili cambiamenti senza previa comunicazione. dBTechnologies si riserva il diritto di apportare cambiamenti o miglioramenti nel design o nelle lavorazioni senza assumersi l'obbligo di cambiare o migliorare anche i prodotti precedentemente realizzati.



A.E.B. Industriale Srl
Via Brodolini, 8
Località Crespellano
40053 VALSAMOGGIA
BOLOGNA (ITALIA)

Tel +39 051 969870
Fax +39 051 969725

www.dbtechnologies.com
info@dbtechnologies-aeb.com

TABLE OF CONTENTS

1. GENERAL INFORMATION	19
WELCOME!	19
PRODUCT OVERVIEW.....	19
USER REFERENCE.....	19
MECHANICAL AND ACOUSTICAL FEATURES.....	20
DIMENSIONS.....	20
FEATURES OF THE AMPLIFIER AND CONTROL SECTIONS.....	21
INPUT, OUTPUT AND CONTROL SECTION.....	22
POWER SUPPLY UNIT SECTION.....	23
2. FIRST POWER-UP.....	24
INPUT CONNECTIONS AND AUDIO DAISY CHAIN.....	25
3. USAGE EXAMPLES.....	27
FLOOR USAGE.....	27
USAGE WITH SPEAKER IN A STACK	27
USAGE ON SUBWOOFER WITH TELESCOPIC POLE.....	27
4. TROUBLESHOOTING.....	28
5. SPECIFICATIONS	29
GENERAL INFORMATION	29
ACOUSTICAL SPECIFICATIONS.....	29
AMPLIFIER.....	29
PROCESSOR.....	30
USER INTERFACE	30
INPUTS & OUTPUTS.....	30
POWER SUPPLY SPECIFICATIONS (ABSORPTION / INSTALLATION)	30
DIMENSIONS.....	31

1. GENERAL INFORMATION

WELCOME!

Thanks for purchasing a product designed and developed in Italy by dBTechnologies! This ergonomic and versatile active subwoofer is the result of a long experience in the sound reinforcement industry, making use of optimized sound, electronic and material research solutions.

PRODUCT OVERVIEW

The new SUB 900 subwoofers are equipped with a 15" woofer (SUB 915) and an 18" woofer (SUB 918), respectively. Accurate design and sound optimisation allow for high-quality performance in a compact product. Cabinets high ergonomics and ease of handling make them easy to transport. SUB 915 and SUB 918 main features are:

- an ergonomic, compact and versatile project, for both indoors and outdoors
- wooden cabinets for acoustic performance optimisation, with resistant external surfaces for both indoor and outdoor use
- reliable, silent digital amplifier
- dedicated DSP controls, with Polarity, Delay, Xover, Sensitivity selection

USER REFERENCE

To make the most of your subwoofer, we recommend that you:

- read the quick start user manual included in the package and this user manual thoroughly and keep this manual during the whole life of the product.
- Register your product at <http://www.dbtechnologies.com> under "[SUPPORT](#)".
- keep proof of purchase and WARRANTY (User manual "section 2").

MECHANICAL AND ACOUSTICAL FEATURES

DIMENSIONS

SUB 915 and S918 have the following sizes:

- SUB 915: 620 x 457 x 620 (mm)
- SUB 918: 720 x 530 x 690 (mm)

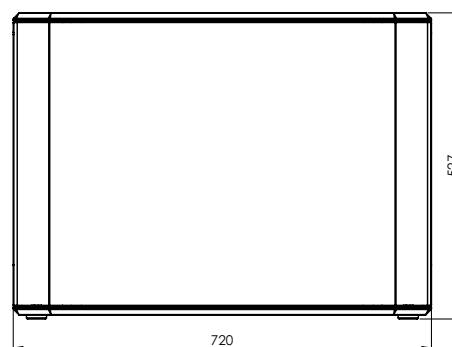
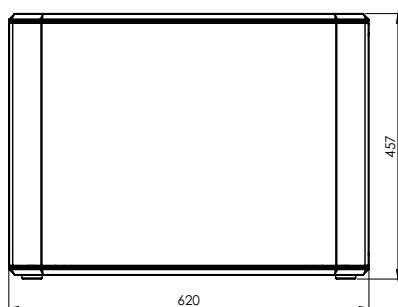
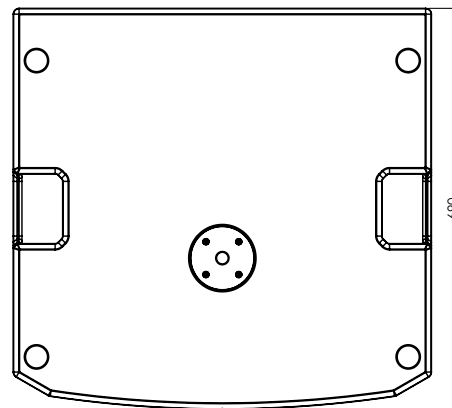
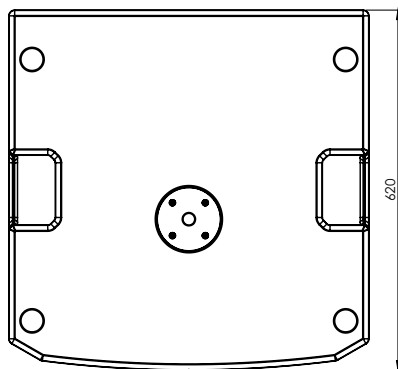

FEATURES OF THE AMPLIFIER AND CONTROL SECTIONS

The Digipro G3 amplifier is at the heart of SUB 915 and SUB 918.

The system is silent and is controlled by a dedicated DSP that manages the different parameters.

The sound amplification power is 900 W RMS.

The amplifier panel is made up of:

- Input, Output and Control Section
- Power Supply Unit Section



WARNING!

- Never attempt to disassemble the amplifier in any way.
- If the module heats up excessively, the audio volume is gradually reduced until the module is thermally stabilized. The audio is automatically restored when the normal operating temperature is reached.
- In the event of a malfunction, remove power supply immediately by disconnecting the unit from the power mains and contact an authorised repair centre.



WARNING!

- Never remove the front grille protecting the product. To prevent the danger of electric shock, in case of accidental damage or replacement of the protection grille (to be carried out at the service), immediately disconnect the power supply. Never connect mains power supply when the grille is removed.

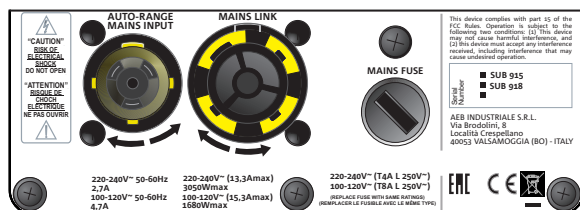
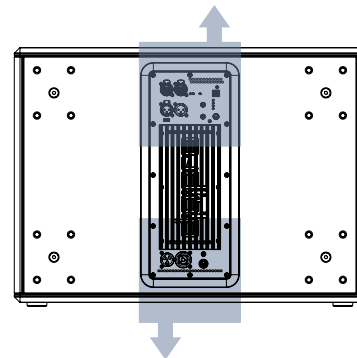
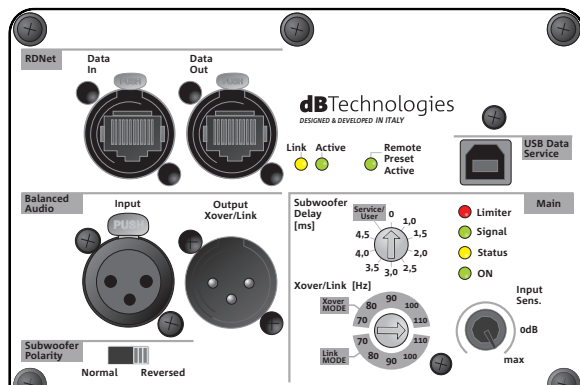

INPUT, OUTPUT AND CONTROL SECTION

POWER SUPPLY UNIT SECTION

INPUT, OUTPUT AND CONTROL SECTION

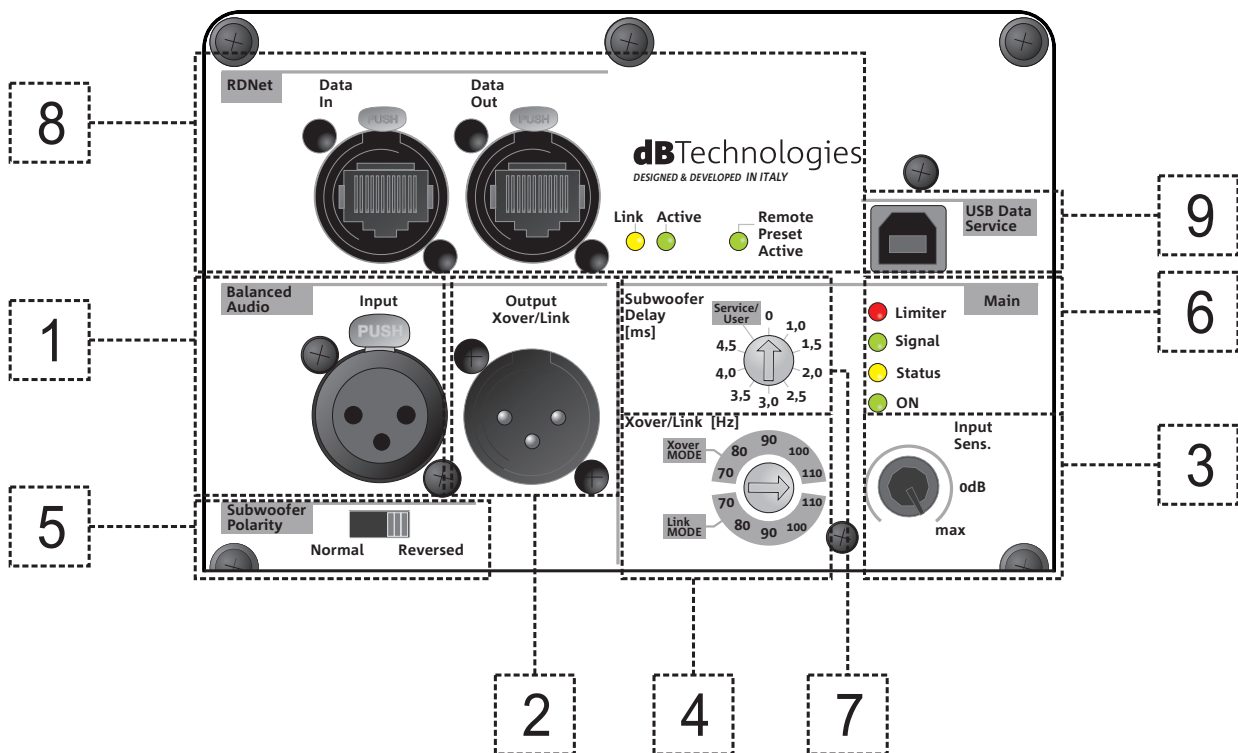

1. INPUT

XLR (balanced) input connector. For further details concerning connection, refer to *INPUT CONNECTIONS AND AUDIO DAISY CHAIN*.

2. OUTPUT

XLR (balanced) output connector. Select the cut-off frequency based on the Xover/Link mode using the relevant rotary control. For further details concerning connection, refer to *INPUT CONNECTIONS AND AUDIO DAISY CHAIN*.

3. Input Sensitivity

Rotary control to adjust the input sensitivity.

4. Xover/Link rotary

Selector that allows setting the cut-off frequency based on the selected mode (Link/Xover). It acts on the daisy-chained signal from *Xover/Link Output* connectors.

5. Subwoofer Polarity selector

Selector that allows adjusting the Polarity (Normal or Reverse)

6. LED (Limiter, Signal/ON)

Indicator LEDs. The Limiter LED turns on when the internal protection circuit is triggered, while Signal/ON indicates subwoofer power-up as well as the presence of an input audio signal.

POWER SUPPLY UNIT SECTION

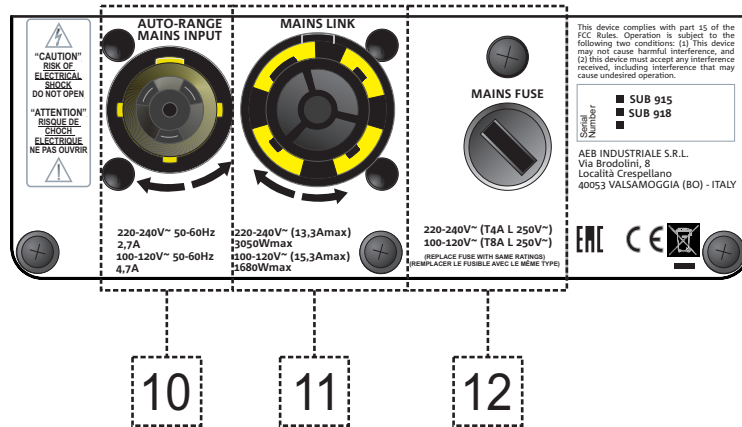

7. Subwoofer Delay

Rotary control that allows setting the delay in ms.

8. RDNet section with control LEDs

Section compatible with network cables with etherCON/RJ45 connectors.

In particular, "Data in" must be connected to devices such as RDNet Control 2 or Control 8; "Data Out" is used to link the network to additional modules of the line array in daisy-chain configuration.

The LEDs relating to module network operation (RDNet) ensure real-time monitoring.

In particular, if "Link" is on the RDNet network is active and has acknowledged the device, if "Active" is flashing there is data traffic, if "Remote Preset Active" is on all local control on the amplifier panel are bypassed by the RDNet remote control.

9. Service Data USB

USB connector for firmware update.

10. MAINS INPUT

Compatible with powerCON TRUE1® connector.

11. MAINS LINK

Compatible with powerCON TRUE1® connector for power daisy chain to other modules.

To find the maximum number of modules that can be connected in a re-linked system, see the [TECHNICAL SPECIFICATIONS](#) section.

12. MAINS FUSE

Housing for the mains fuse

2. FIRST POWER-UP

The package of SUB 915 / SUB 918 subwoofer contains:

- 915 or 918 subwoofer
- POWERCON TRUE1 power cable
- quick start user manual and warranty documents in hard copy

CONFIGURATION AND OPTIMISATION

The subwoofer will turn on after inserting, turning and connecting the powerCON TRUE1® connector to the power supply.

For subwoofer use optimisation in given configurations, the control panel displays the following:

- Xover/Link [Hz]:
 1. Link (the signal present at OUTPUTS is the one applied to the woofer)
 2. Xover (the signal present at OUTPUTS is filtered with a crossover frequency of 120 Hz, for daisy chain to a speaker, such as B-HYPE and OPERA)
- Subwoofer Polarity:
 1. Normal (audio signal normal polarity)
 2. Reverse (reverse polarity, useful for wavefront optimisation through acoustic wave phase reversal)
- Subwoofer Delay:

It is possible to select the applicable delay for various configurations, according to what is stated on the silk-screen print.

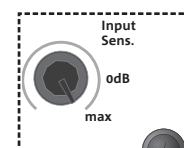
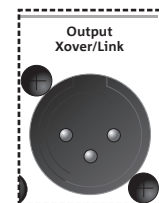
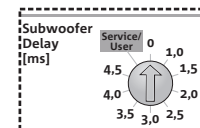
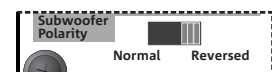
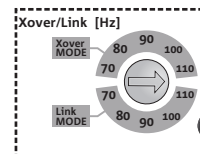

Before power-up, set Input Sensitivity level selector to 0 dB

INPUT CONNECTIONS AND AUDIO DAISY CHAIN

Two example figures are shown for illustrative purposes only.

In the event of a connection between subwoofer and speaker:

1. Connect mixer output to subwoofer input connector
2. Connect subwoofer output connector to speaker input.
3. Set subwoofer OUTPUT XOVER/LINK [4] to XOVER, in order to daisy-chain a signal to the speaker having a crossover frequency that can be selected with the Xover/Link rotary control [Hz]

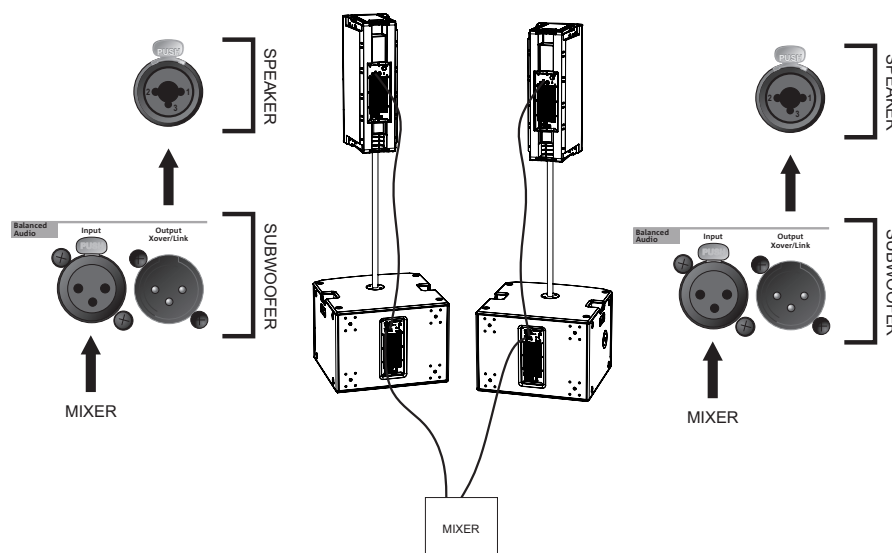
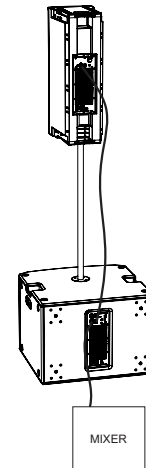
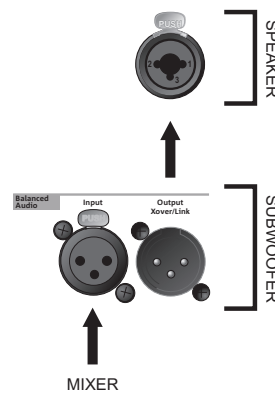

* Balanced

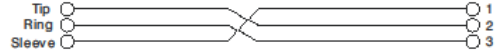
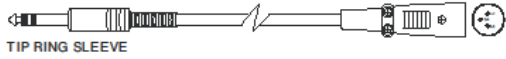
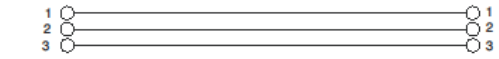
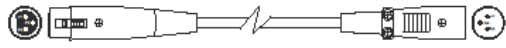
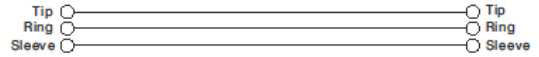
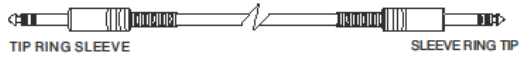

* Unbalanced

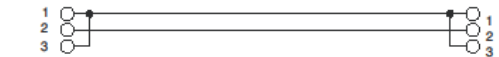
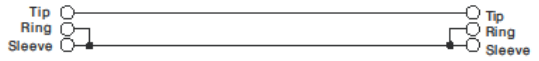
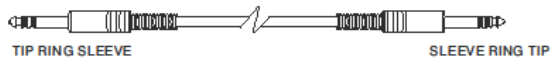
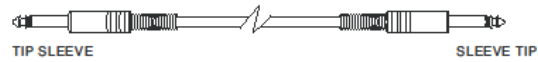
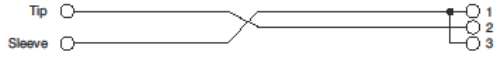
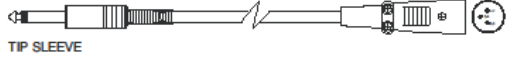
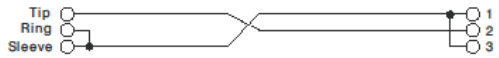
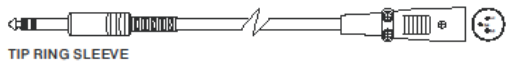

3. USAGE EXAMPLES



- Types of installation other than those here described are not allowed.
- Never use the handles to suspend the subwoofer
- Always check that the positioning is stable and that the installation does not pose a danger to people, animals or property.

FLOOR USAGE

915 and 918 subwoofers may be used directly on the floor.

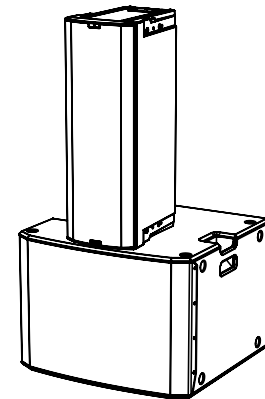

USAGE WITH SPEAKER IN A STACK

A speaker may be installed directly on 915 or 918 subwoofer by means of a DS2-S 35 mm diameter mini-pole (e.g. series: INGENIA, B-HYPE, OPERA).

An additional fastener is required.

USAGE ON SUBWOOFER WITH TELESCOPIC POLE

It is possible to use only one speaker mounted on a 35 mm diameter pole. The reference accessory is DS-2 (telescopic pole). An additional fastener is required.

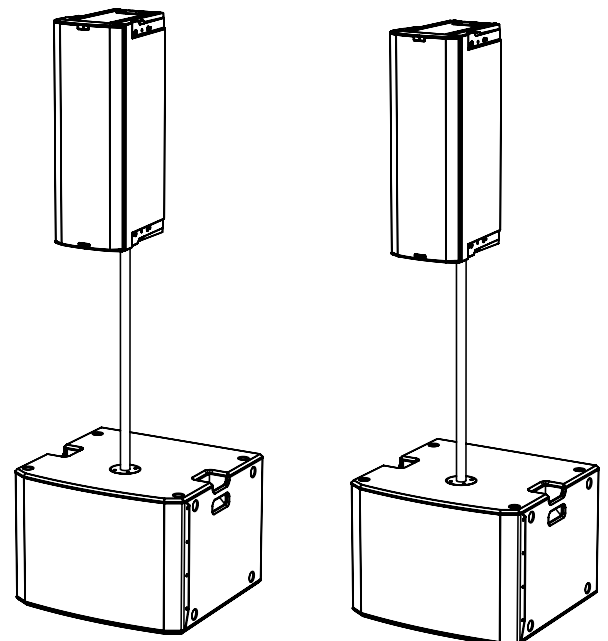

4. TROUBLESHOOTING

The subwoofer will not turn on:

1. Check that power supply is present upstream of the installation.
2. Ensure that the power supply cable is properly plugged in.

The subwoofer turns on but produces no sound:

1. Check that the input connection of the audio signal is correctly performed.
2. Check the cables for damage.
3. Ensure that the mixer or audio source is on and an output signal is present.
4. Check the general level through the "Input Sensitivity" control.

Loudspeaker sound is inappropriate:

1. Check the cables for damage and replace them as required (a damaged cable may lead to signal loss or alteration).
2. Check that the settings on the control panel are correctly set.

5. SPECIFICATIONS

GENERAL INFORMATION

Type:	Active subwoofer
-------	------------------

ACOUSTICAL SPECIFICATIONS

Frequency response [-10dB]:	45 - Cut freq Hz (SUB 915) / 42 -Cut Freq Hz (SUB 918)
Max SPL (1m):	133 dB (SUB 915) / 134 dB (SUB 918)
LF:	15" (SUB 915) / 18" (SUB 918)
LF voice coil:	4"
Crossover frequency:	Variable (70 Hz - 80 Hz - 90 Hz - 100 Hz - 110 Hz)

AMPLIFIER

Type:	DIGIPRO G3
Amplification class	Class D
Power supply	PowerCON TRUE1
RMS amplifier power:	900 W

PROCESSOR

Internal controller:	28-bit/56-bit DSP
Limiter:	Peak, RMS, Thermal

USER INTERFACE

Controls:	Delay, Xover/Link, Polarity, Sensitivity
-----------	--

INPUTS & OUTPUTS

Inputs:	2 x XLR Balanced Inputs
Outputs:	2x XLR Balanced Outputs

POWER SUPPLY SPECIFICATIONS (ABSORPTION / INSTALLATION)

Absorption at 1/8th of power in medium use conditions (*):	1.2 A (220-240V~) - 2 A (110-120V~)
Absorption at 1/3rd of power in maximum use conditions (**):	2.7 A (220-240V~) - 4.7 A (110-120V~)
Absorption with speaker on in no-signal condition (idle):	21 W
Inrush current:	21.04 A

*** NOTE FOR INSTALLER:** Values refer to 1/8th of power, under average operating conditions (music programme with occasional or no clipping). For any type of configuration we recommend to consider them as minimum sizing values.

**** NOTE FOR INSTALLER:** Values refer to 1/3rd of power, under heavy operating conditions (music programme with frequent clipping and limiter activation). In case of professional installations and tours we recommend sizing according to these values.

DIMENSIONS

Material:	Plywood (with protective black paint)
Grille:	NC-machined
Handles:	2, on sides
Pole mount:	Yes, 36 mm (provision: M20)
Width:	620 mm (SUB 915) 720 mm (SUB 918)
Height:	457 mm (SUB 915) 530 mm (SUB 918)
Depth:	620 mm (SUB 915) 690 mm (SUB 918)
Weight:	34.8 kg (SUB 915) 41.8 kg (SUB 918)

Product features, specifications and appearance are subject to changes without prior notice. dBTechnologies reserves the right to make changes or improvements in design or manufacture without any obligation to incorporate such changes or improvements in products manufactured before their introduction.



A.E.B. Industriale Srl
Via Brodolini, 8
Località Crespellano
40053 VALSAMOGGIA
BOLOGNA (ITALY)

Tel +39 051 969870
Fax +39 051 969725

www.dbtechnologies.com
info@dbtechnologies-aeb.com

INHALTSVERZEICHNIS

1. ALLGEMEINE INFORMATIONEN	33
WILLKOMMEN!	33
EINLEITENDER ÜBERBLICK	33
ANHALTSPUNKTE FÜR DEN BENUTZER.....	33
MECHANISCHE UND AKUSTISCHE EIGENSCHAFTEN.....	34
<i>ABMESSUNGEN</i>	34
EIGENSCHAFTEN DES VERSTÄRKUNGS- UND STEUERBEREICHS.....	35
<i>INPUT, OUTPUT- UND STEUERBEREICH</i>	36
<i>VERSORGUNGSBEREICH</i>	37
2. ERSTMALIGES EINSCHALTEN.....	38
<i>VERBINDUNG DER AUDIO-EINGÄNGE UND RÜCKLAUF</i>	39
3. ANWENDUNGSBEISPIELE	41
VERWENDUNG AM BODEN	41
VERWENDUNG MIT LAUTSPRECHER IM STACK.....	41
VERWENDUNG AUF EINEM SUBWOOFER MIT TELESKOPPFOSTEN	41
4. PROBLEMABHILFE	42
5. TECHNISCHE DATEN	43
<i>ALLGEMEINE ANGABEN</i>	43
<i>AKUSTIK-DATEN</i>	43
<i>VERSTÄRKER</i>	43
<i>PROZESSOR</i>	44
<i>BENUTZEROBERFLÄCHE</i>	44
<i>EINGÄNGE UND AUSGÄNGE</i>	44
<i>VERSORGUNGSSPEZIFIKATIONEN (AUFNAHME / INSTALLATION)</i>	44
<i>ABMESSUNGEN</i>	45

1. ALLGEMEINE INFORMATIONEN

WILLKOMMEN!

Wir danken Ihnen, dass Sie sich für den Kauf eines von dBTechnologies in Italien entworfenen und entwickelten Produkts entschieden haben! Dieser vielseitige und ergonomische Aktiv-Subwoofer ist das Resultat einer langjährigen Erfahrung im Bereich der Beschallungssysteme mit optimierten Lösungen in Sachen Akustik und Elektronik sowie in der Wahl der Materialien.

EINLEITENDER ÜBERBLICK

Die neuen Subwoofer der Serie SUB 900 sind jeweils mit einem 15-Zoll-Tieftöner (SUB 915) und einem 18-Zoll-Tieftöner (SUB 918) ausgestattet. Die präzise Planung und die akustische Optimierung bieten eine hochqualitative Leistung in einem Produkt im kompakten Format. Dank ihres hohen ergonomischen Aspekts und ihrer Handlichkeit lassen sich die Gehäuse leicht transportieren.

Die Haupteigenschaften von SUB 915 und SUB 918 sind:

- ein ergonomisches, kompaktes und vielseitiges Design für Indoor- und Outdoor-Kontexte
- Holzgehäuse zur Optimierung der akustischen Leistung mit widerstandsfähiger Außenfläche für den Indoor- und Outdoor-Einsatz
- zuverlässiger Verstärker mit besonderer Laufruhe
- spezifische Steuerungen des DSP mit Wahlmöglichkeit der Polarität, von Delay, Xover, Sensitivity

ANHALTSPUNKTE FÜR DEN BENUTZER

Zur besten Verwendung Ihres Subwoofers empfehlen wir:

- die in der Packung enthaltene Quick Start-Anleitung sowie die vorliegende komplette Bedienungsanleitung in allen ihren Teilen zu lesen und sie über die gesamte Lebensdauer des Produkts hinweg aufzubewahren;
- das Produkt auf der Website <http://www.dbtechnologies.com> im Abschnitt „**ASSISTENZ**“ zu registrieren.
- und die Kaufquittung sowie die GARANTIE (Bedienungsanleitung „Abschnitt 2“) gut aufzubewahren.

MECHANISCHE UND AKUSTISCHE EIGENSCHAFTEN

ABMESSUNGEN

Die Abmessungen des SUB 915 und des S918 sind:

- SUB 915: 620 x 457 x 620 (mm)
- SUB 918: 720 x 530 x 690 (mm)

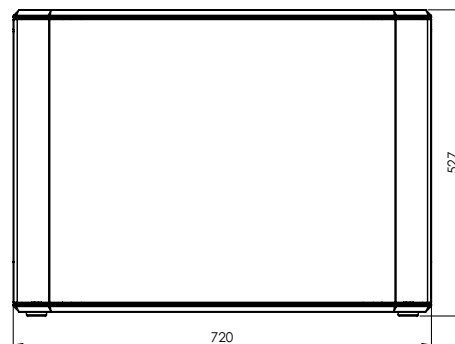
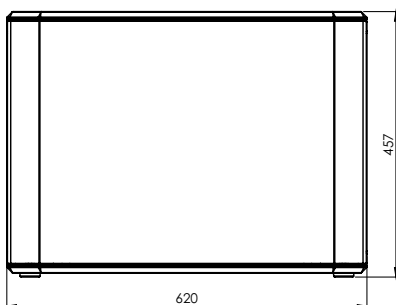
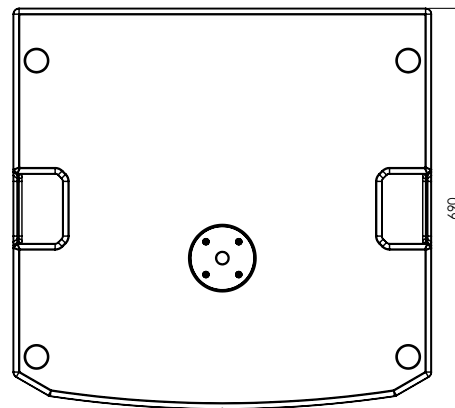
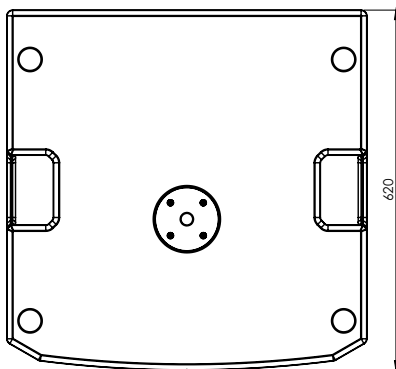

EIGENSCHAFTEN DES VERSTÄRKUNGS- UND STEUERBEREICHS

Der Verstärker Digipro G3 ist das Herzstück der Modelle SUB 915 und SUB 918. Das System weist eine besondere Laufruhe auf und wird von einem dedizierten DSP gesteuert, der verschiedene Parameter verwaltet. Die Schallverstärkungsleistung beträgt 900 W RMS.

Das Panel des Verstärkers verfügt über:

- Eingang, Ausgang und Steuerbereich
- Versorgungsteil



ACHTUNG!

- Versuchen Sie nicht, den Verstärker zu öffnen.
- Wenn sich das Modul übermäßig erwärmt, reduziert sich allmählich die Lautstärke, bis das Modul thermisch wieder stabilisiert ist. Der Pegel wird automatisch wiederhergestellt, wenn die normale Betriebstemperatur erreicht ist.
- Bei Funktionsstörungen sofort die Stromversorgung unterbrechen, indem Sie das Modul vom Stromnetz trennen und sich dann an einen autorisierten Techniker wenden.



ACHTUNG!

- Entfernen Sie nie das Frontschutzgitter des Produkts. Um die Gefahr eines Stromschlags zu vermeiden, muss bei einer Beschädigung oder einem Austausch des Schutzgitters (der vom Kundendienst vorgenommen werden muss) sofort die Stromversorgung getrennt werden. Die Versorgung nie anschließen, wenn das Schutzgitter entfernt worden ist.

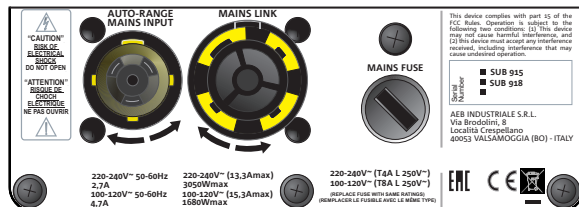
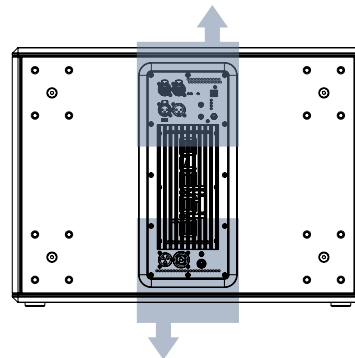
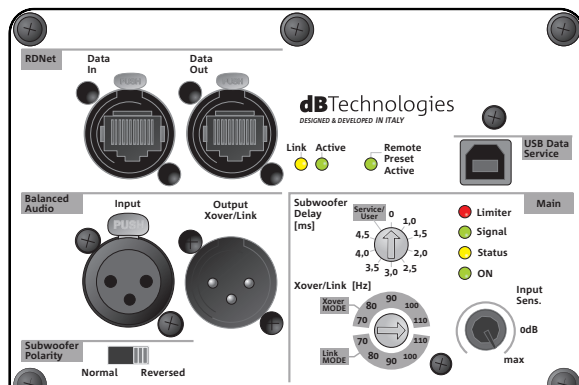

EINGANG, AUSGANG UND STEUERBEREICH

VERSORGUNGSBEREICH

INPUT-, OUTPUT- UND STEUERBEREICH

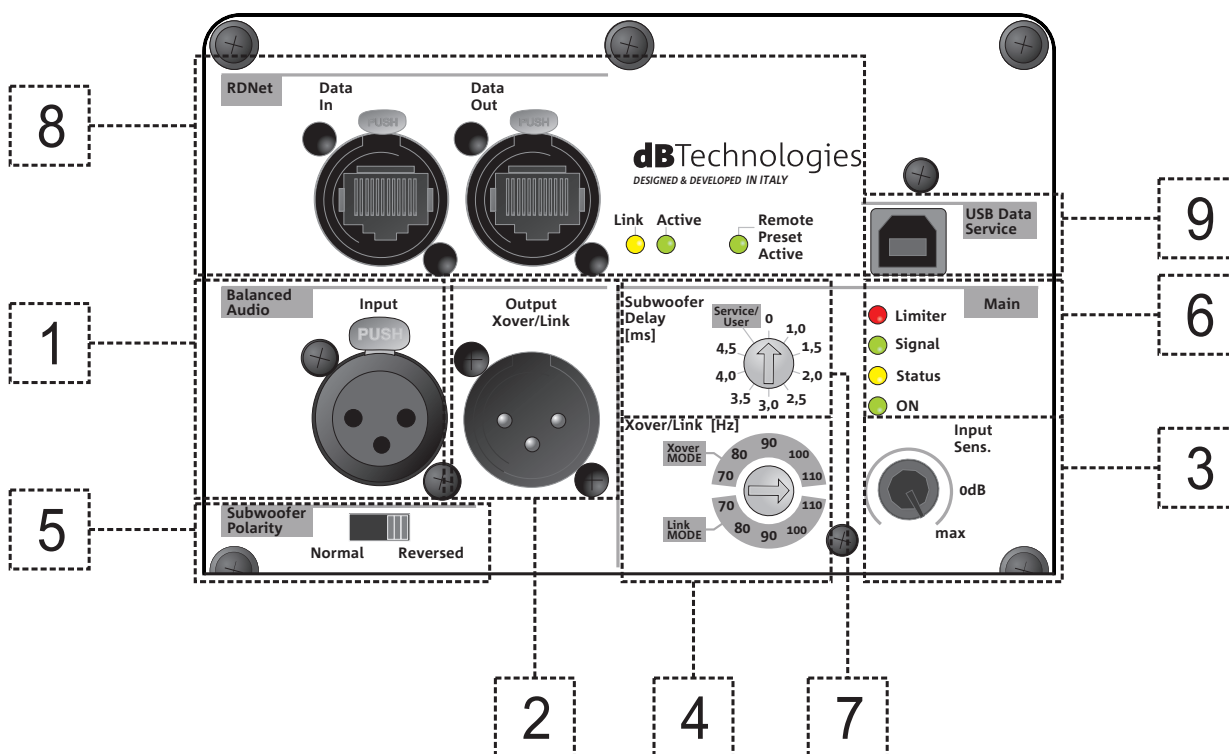

1. **INPUT**

Eingangssteckverbinder, Typ XLR (symmetrisch). Für Details bezüglich der Verbindungen siehe Abschnitt *VERBINDUNG DER EINGÄNGE UND AUDIO-WEITERGABE*.

2. **OUTPUT**

Ausgangssteckverbinder, Typ XLR (symmetrisch). Die Trennfrequenz des Modus Xover/Link am entsprechenden Drehschalter wählen. Für Details bezüglich der Verbindungen siehe Abschnitt *VERBINDUNG DER EINGÄNGE UND AUDIO-WEITERGABE*.

3. **Input Sensitivity**

Drehschalter zum Einstellen der Eingangsempfindlichkeit.

4. **Xover/Link rotary**

Wählschalter, der das Einstellen der Trennfrequenz abhängig vom zuvor gewählten Modus (Link/Xover) ermöglicht. Wirkt auf das von den Steckverbindern weitergegebene Signal *Output Xover/Link* aus.

5. **Selettore Subwoofer Polarity**

Wählschalter, der ein Einwirken auf die Polarität (Normal oder Reverse) ermöglicht.

6. **LED (Limiter, Signal/ON)**

Anzeige-LEDs. Die LED Limiter leuchtet beim Ansprechen des internen Schutzschaltkreises auf. Das Signal/ON weist auf das erfolgte Einschalten des Subwoofers und auf das Vorhandensein eines eingehenden Audiosignals hin.

VERSORGUNGSBEREICH

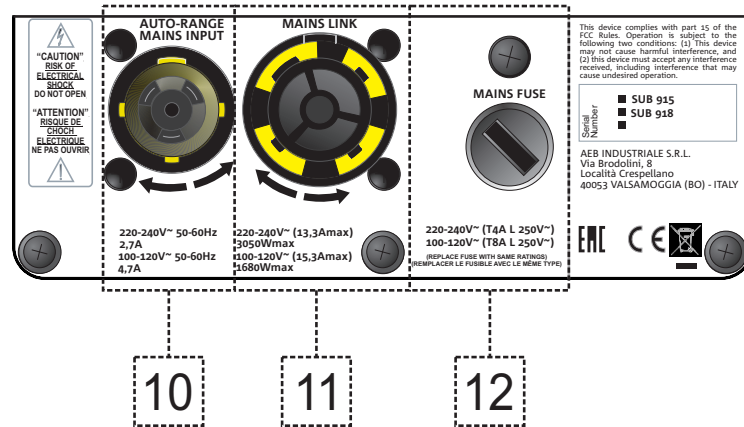

7. Subwoofer Delay

Drehschalter, der eine Verzögerung (delay) in ms ermöglicht.

8. Teil RDNet mit Kontrollanzeige-LED

Mit Netzkabeln mit Steckverbindern etherCON / RJ45 kompatibler Teil.

Insbesondere muss „Data in“ mit Geräten wie RDNet Control 2 oder Control 8 verbunden werden; „Data Out“ wird für die Weitergabe des Netzwerks an andere Module des Line Arrays in einer Daisy-Chain-Konfiguration verwendet.

Die LEDs der Anzeige des Betriebs innerhalb der Netzeinbindung (Rdnet) des Moduls gewährleistet eine Echtzeitüberwachung.

Insbesondere weist das Aufleuchten von „Link“ darauf hin, dass das Netz RDNet aktiv ist und das Gerät erkannt hat; blinkt „Active“ auf, bedeutet dies, dass ein Datenaustausch vorliegt; „Remote Preset Active“ gibt an, dass alle lokalen Bedienelemente am Bedienfeld des Verstärkers von der Fernsteuerung RDNet umgangen werden.

9. USB Data Service

USB-Anschluss für die Aktualisierung der Firmware.

10. MAINS INPUT

Mit dem Verbinder powerCON TRUE1® kompatibel.

11. MAINS LINK

Kompatibel mit einem powerCON TRUE1®-Stecker zum Rücklauf der Stromversorgung anderer Module.

Die maximale Anzahl der Module, die in einem neu gestarteten System angeschlossen werden können, finden Sie im Abschnitt [TECHNISCHE DATEN](#).

12. MAINS FUSE

Gehäuse der Netzsicherung

2. ERSTMALIGES EINSCHALTEN

Der Lieferumfang des Subwoofer SUB 915 / SUB 918 enthält:

- Subwoofer 915 oder Subwoofer 918
- Anschlusskabel POWERCON TRUE1
- Quick Start-Anleitung und Garantieschein

KONFIGURATION UND OPTIMIERUNG

Wurde der an die Netzversorgung angeschlossene Stecker powerCON TRUE1® eingesteckt und gedreht, schaltet sich der Subwoofer ein.

Um die Verwendung des Subwoofers für einige besondere Konfigurationen zu optimieren, steht dem Bediener am Bedienfeld Folgendes zur Verfügung:

- Xover/Link [Hz]:
 1. Link (das an den Ausgängen OUTPUTS vorhandene Signal ist das am Tieftöner (woofer) angewendete)
 2. Xover (das an den Ausgängen OUTPUTS vorhandene Signal wird mit einer Übergangsfrequenz von 120 Hz für die Weitergabe an Lautsprecher, wie zum Beispiel B-HYPE und OPERA, gefiltert)
- Subwoofer Polarity:
 1. Normal (Normale Polarität des Audiosignals)
 2. Reverse (Umgekehrte Polarität, nützliche Option für die Optimierung der Wellenfront durch Umkehrung der Schallwellenphase)
- Subwoofer Delay:

Hier kann das Delay gewählt werden, dass für verschiedene Konfigurationen, gemäß Angaben auf dem Siebdruck angewendet werden kann.

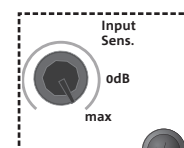
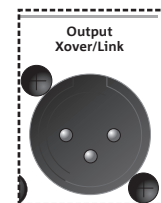
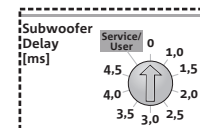
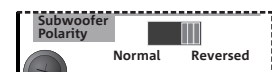
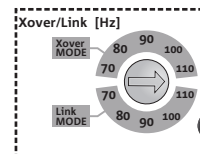

Vor dem Einschalten wird empfohlen, den Wählschalter des Pegels Input Sensitivity auf 0 dB zu stellen

VERBINDUNG DER AUDIO-EINGÄNGE UND RÜCKLAUF

Als reines Beispiel werden 2 Abbildungen bereitgestellt

Bei einer Verbindung zwischen Subwoofer und Lautsprecher:

1. Den Ausgang des Mixers mit dem Eingangsstecker des Subwoofers anschließen
2. Den Ausgangsstecker des Subwoofers an den Lautsprechereingang schließen.
3. OUTPUT XOVER/LINK [4] des Subwoofers auf XOVER stellen, um ein Signal mit Übergangsfrequenz weiterzugeben, das über den Drehschalter Xover/Link [Hz] gewählt werden kann

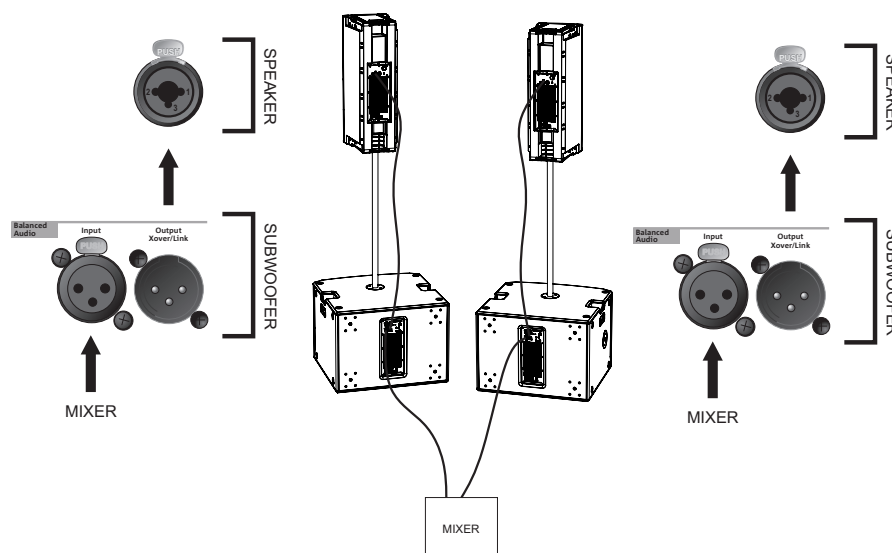
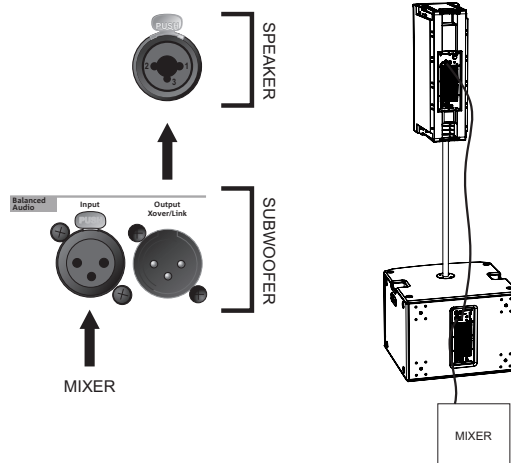

* Balanced

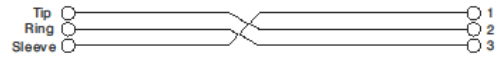
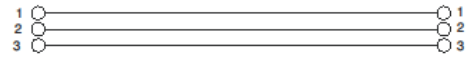
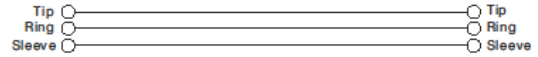
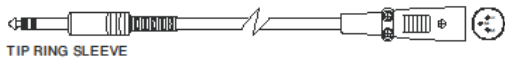
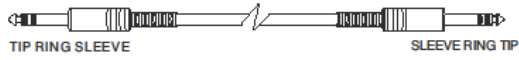

* Unbalanced

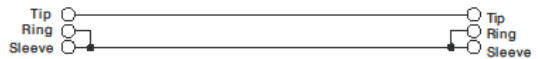
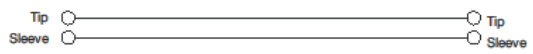
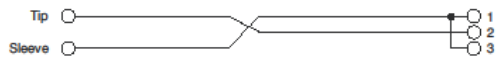
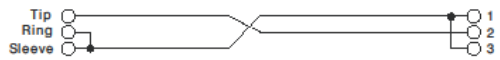
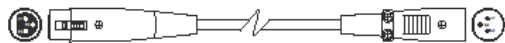
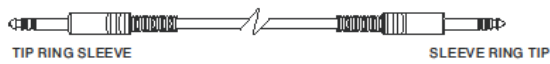
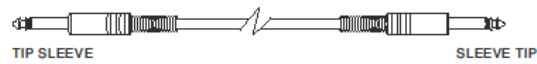
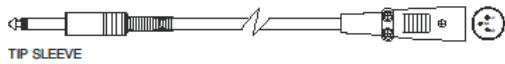
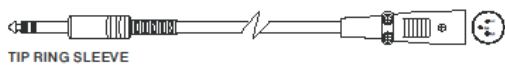

3. ANWENDUNGSBEISPIELE



- Andere als die hier dargestellten Installationen sind nicht zulässig.
- Verwenden Sie die Griffe des Subwoofers nie um ihn daran aufzuhängen.
- Überprüfen Sie stets, dass er stabil angeordnet ist und dass die Installation keine Gefahrenquelle für Personen, Tiere oder Gegenstände darstellt.

VERWENDUNG AM BODEN

Die Subwoofer 915 und 918 können direkt am Boden stehend verwendet werden.

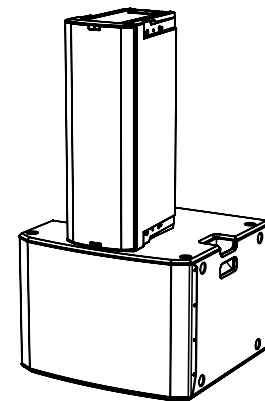

VERWENDUNG MIT LAUTSPRECHER IM STACK

Die Verwendung eines Lautsprechers, der direkt auf dem Subwoofer 915 oder 918 montiert ist, ist bei Einsatz eines Mini-Pfeilers mit einem Durchmesser von 35 mm DS2-S möglich (z. B. Serie: INGENIA, B-HYPE, OPERA). Hier ist eine zusätzliche Befestigung erforderlich

VERWENDUNG AUF EINEM SUBWOOFER MIT TELESKOPFPOSTEN

Es besteht die Möglichkeit, einen einzigen Lautsprecher auf einem Pfosten mit 35 mm Durchmesser zu montieren. Das Bezugzubehörteil ist das DS-2 (Teleskoppfosten). Hier ist eine zusätzliche Befestigung erforderlich

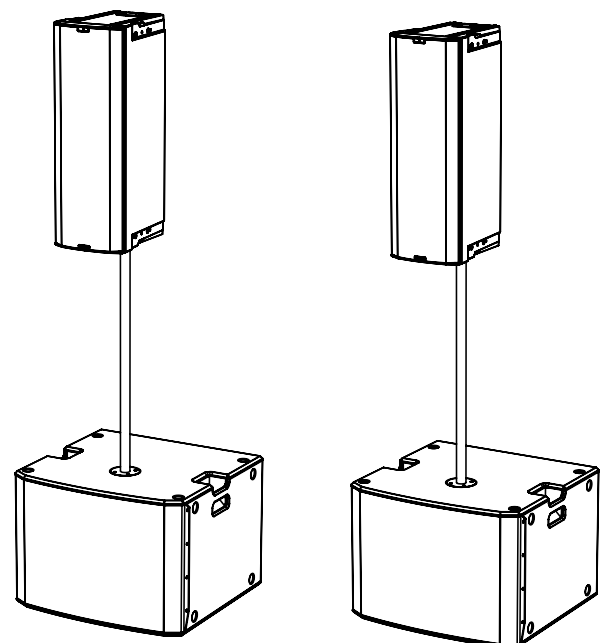

4. PROBLEMABHILFE

Der Subwoofer lässt sich nicht einschalten:

1. Überprüfen Sie das Vorhandensein der korrekten, der Anlage vorgeschalteten Versorgung.
2. Überprüfen Sie, dass das Anschlusskabel korrekt eingesteckt ist.

Der Subwoofer lässt sich einschalten, gibt jedoch keine Töne ab:

1. Überprüfen Sie, dass die Verbindung am Eingang des Audiosignals korrekt erfolgt ist.
2. Überprüfen Sie, dass die verwendeten Kabel nicht beschädigt sind.
3. Überprüfen Sie, dass der Mixer oder die Audioquelle eingeschaltet sind und das Vorhandensein des Ausgangssignals deutlich angezeigt wird.
4. Überprüfen Sie die allgemeine Stufe über die Steuerung „Input Sensitivity“.

Der Lautsprecher gibt einen unangemessenen Klang ab:

1. Überprüfen Sie, dass die verwendeten Kabel keine Beschädigungen aufweisen. Sollte dies der Fall sein, müssen sie ersetzt werden (ein beschädigtes Kabel kann zum Signalverlust oder dessen Verfälschung führen).
2. Überprüfen Sie, dass die Einstellungen am Bedienpult korrekt sind.

5. TECHNISCHE DATEN

ALLGEMEINE ANGABEN

Typ:	Aktiv-Subwoofer
------	-----------------

AKUSTIK-DATEN

Frequenzgang [-10dB]:	45 - Cut freq Hz (SUB 915) / 42 -Cut Freq Hz (SUB 918)
Max SPL (1 m):	133 dB (SUB 915) / 134 dB (SUB 918)
LF:	15 Zoll (SUB 915) / 18 Zoll (SUB 918)
LF Schwingspule:	4"
Übergangsfrequenz:	Variabel (70 Hz - 80 Hz - 90 Hz - 100 Hz - 110 Hz)

VERSTÄRKER

Typ:	DIGIPRO G3
Verstärkerklasse	Klasse D
Stromversorgung	PowerCON TRUE1
Verstärkerleistung RMS:	900 W

PROZESSOR

Interner Controller:	DSP 28/56 bit
Limiter (Begrenzer):	Peak, RMS, Thermoschalter

BENUTZEROBERFLÄCHE

Bedienelemente:	Delay, Xover/Link, Polarity, Sensitivity
-----------------	--

EINGÄNGE UND AUSGÄNGE

Eingänge:	2 x XLR Balanced Inputs
Ausgänge:	2x XLR Balanced Outputs

VERSORGUNGSSPEZIFIKATIONEN (AUFNAHME / INSTALLATION)

Aufnahme bei 1/8 der Leistung unter durchschnittlichen Einsatzbedingungen (*):	1,2 A (220-240V~) - 2 A (110-120V~)
Aufnahme bei 1/3 der Leistung unter maximalen Einsatzbedingungen (**):	2,7 A (220-240V~) - 4,7 A (110-120V~)
Aufnahme bei eingeschaltetem Lautsprecher ohne Signal (Leerlauf):	21 W
Einschaltstrom:	21.04 A

*** HINWEIS FÜR DEN INSTALLATEUR:** Die Werte beziehen sich auf 1/8 der Leistung im mittleren Betriebszustand (Musikprogramm mit seltenem oder ohne Clipping). Es wird für jede Art von Konfiguration empfohlen, diese als Mindestgrößen zu betrachten.

**** HINWEIS FÜR DEN INSTALLATEUR:** Die Werte beziehen sich auf 1/3 der Leistung im schweren Betriebszustand (Musikprogramm mit häufigem Clipping und Ansprechen des Limiters). Bei professionellen Installationen und Touren empfiehlt es sich, nach diesen Werten zu dimensionieren.

ABMESSUNGEN

Material:	Mehrschichtholz (mit schwarzer Schutzlackierung)
Gitter:	CNC-Verarbeitung
Griffe:	2, seitliche
Montage auf Pfosten:	Ja, 36 mm (Auslegung: M20)
Breite:	620 mm (SUB 915) 720 mm (SUB 918)
Höhe:	457 mm (SUB 915) 530 mm (SUB 918)
Tiefe:	620 mm (SUB 915) 690 mm (SUB 918)
Gewicht:	34,8 kg (SUB 915) 41,8 kg (SUB 918)

Die Eigenschaften, die Spezifikationen sowie das Erscheinungsbild der Produkte können ohne vorherige Ankündigung geändert werden. dBTechnologies behält sich das Recht vor, Änderungen und Verbesserungen am Design oder den Ausführungen vornehmen zu können, ohne die Verpflichtung einzugehen, zuvor hergestellte Produkte ändern oder verbessern zu müssen.



A.E.B. Industriale Srl
Via Brodolini, 8
Località Crespellano
40053 VALSAMOGGIA
BOLOGNA (ITALIA)

Tel +39 051 969870
Tel +39 051 969725

www.dbtechnologies.com
info@dbtechnologies-aeb.com

TABLE DES MATIÈRES

1. INFORMATIONS GÉNÉRALES	47
BIENVENUS !.....	47
INTRODUCTION	47
RÉFÉRENCES POUR L'UTILISATEUR.....	47
CARACTÉRISTIQUES MÉCANIQUES ET ACOUSTIQUES	48
<i>DIMENSIONS</i>	48
CARACTÉRISTIQUES DE LA SECTION D'AMPLIFICATION ET DE CONTRÔLE.....	49
<i>SECTION D'ENTRÉE, DE SORTIE ET DE CONTRÔLE</i>	50
<i>SECTION D'ALIMENTATION</i>	51
2. PREMIER ALLUMAGE	52
<i>CONNEXION DES ENTRÉES ET RELANCE AUDIO</i>	53
3. EXEMPLES D'UTILISATION	55
UTILISATION AU SOL	55
UTILISATION AVEC ENCEINTE EN STACK	55
UTILISATION SUR SUBWOOFER AVEC POTEAU TÉLESCOPIQUE.....	55
4. DÉPANNAGE	56
5. SPÉCIFICATIONS TECHNIQUES	57
<i>INFORMATIONS GÉNÉRALES</i>	57
<i>DONNÉES ACOUSTIQUES</i>	57
<i>AMPLIFICATEUR</i>	57
<i>PROCESSEUR</i>	58
<i>INTERFACE UTILISATEUR</i>	58
<i>ENTRÉES ET SORTIES</i>	58
<i>SPÉCIFICATIONS D'ALIMENTATION (ABSORPTION / INSTALLATION)</i>	58
<i>DIMENSIONS</i>	59

1. INFORMATIONS GÉNÉRALES

BIENVENUS !

Merci d'avoir acheté un produit conçu et développé en Italie par dBTechnologies ! Ce subwoofer actif polyvalent et ergonomique est le résultat d'une longue d'expérience dans le secteur de la diffusion sonore, offrant des solutions optimisées dans le domaine acoustique et électronique ainsi que pour le choix des matériaux utilisés.

INTRODUCTION

Les nouveaux subwoofers de la série SUB 900 sont équipés d'un woofer de 15" (SUB 915) et un woofer de 18" (SUB 918) respectivement. La conception précise et l'optimisation acoustiques offrent des performances haute qualité renfermées dans un produit aux dimensions contenues. Grâce à leurs ergonomie et maniabilité élevées le transport des coffrets résulte très aisé.

Les caractéristiques principales de SUB 915 et SUB 918 sont :

- un projet ergonomique, compact et polyvalent dans des scénarios à l'intérieur et à l'extérieur
- coffrets en bois pour optimiser les performances acoustiques, avec surface externe haute résistance pour l'utilisation à l'intérieur et à l'extérieur
- amplificateur numérique fiable et silencieux
- contrôles du DSP dédiés, avec sélection de Polarité, Delay, Xover, Sensitivity

RÉFÉRENCES POUR L'UTILISATEUR

Pour utiliser au mieux votre subwoofer il est recommandé de :

- lire le manuel d'utilisation quick start inclus dans l'emballage et le présent manuel d'utilisation dans son intégralité et le conserver pour toute la durée de vie du produit.
- enregistrer le produit sur le site <http://www.dbtechnologies.com> à la section « [SUPPORT](#) ».
- conserver la preuve d'achat et la GARANTIE (Manuel d'utilisation « section 2 »).

CARACTÉRISTIQUES MÉCANIQUES ET ACOUSTIQUES

DIMENSIONS

Les dimensions de SUB 915 et S918 sont :

- SUB 915 : 620 x 457 x 620 (mm)
- SUB 918 : 720 x 530 x 690 (mm)

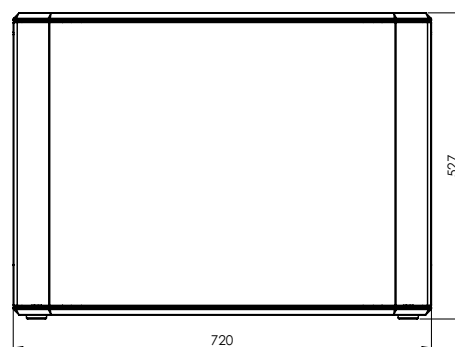
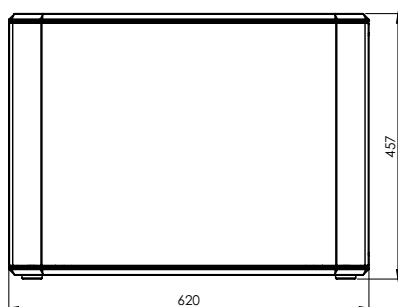
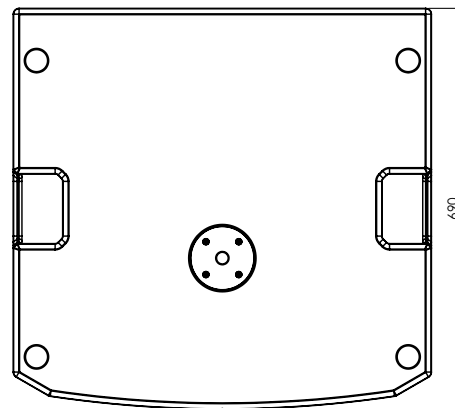
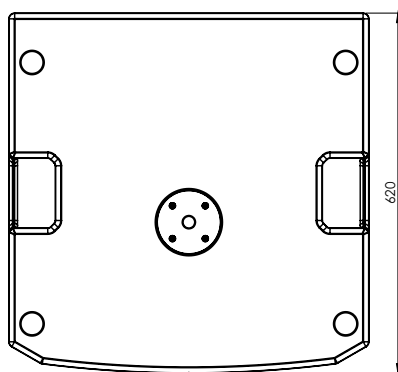

CARACTÉRISTIQUES DE LA SECTION D'AMPLIFICATION ET DE CONTRÔLE

L'amplificateur Digipro G3 est le cœur des SUB 915 et SUB 918.

Le système est silencieux et son contrôle se fait par le biais d'un DSP dédié qui gère plusieurs paramètres.

La puissance de l'amplification sonore est de 900 W RMS.

Le panneau de l'amplificateur est caractérisé par :

- Section d'Entrée de Sortie et de Contrôle
- Section d'Alimentation



ATTENTION !

- N'essayer en aucun cas d'ouvrir l'amplificateur.
- En cas de surchauffe excessive, le volume audio est réduit progressivement jusqu'à la stabilisation thermique du module. Le niveau est rétabli automatiquement lorsque la température correcte de fonctionnement à été atteinte.
- En cas de dysfonctionnement, couper immédiatement l'alimentation et débrancher le module du réseau, puis contacter un réparateur agréé.



ATTENTION !

- Ne jamais démonter la grille frontale de protection du produit. Pour prévenir le danger de choc électrique, en cas d'endommagement accidentel ou de remplacement de la grille de protection (à effectuer auprès du service assistance), couper immédiatement l'alimentation. Ne jamais brancher l'alimentation secteur avec la grille démontée.

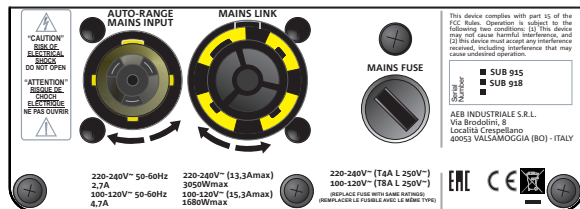
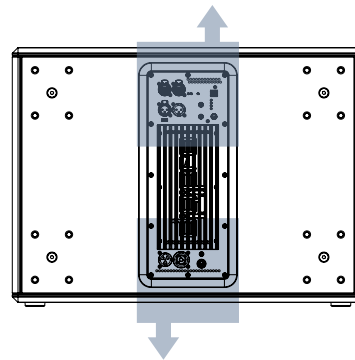
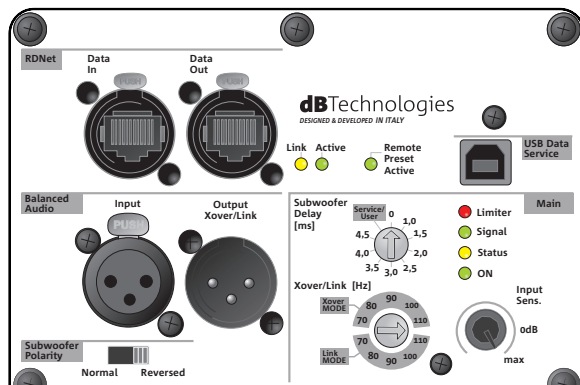

SECTION D'ENTRÉE, DE SORTIE ET DE CONTRÔLE

SECTION D'ALIMENTATION

SECTION D'ENTRÉE, DE SORTIE ET DE CONTRÔLE

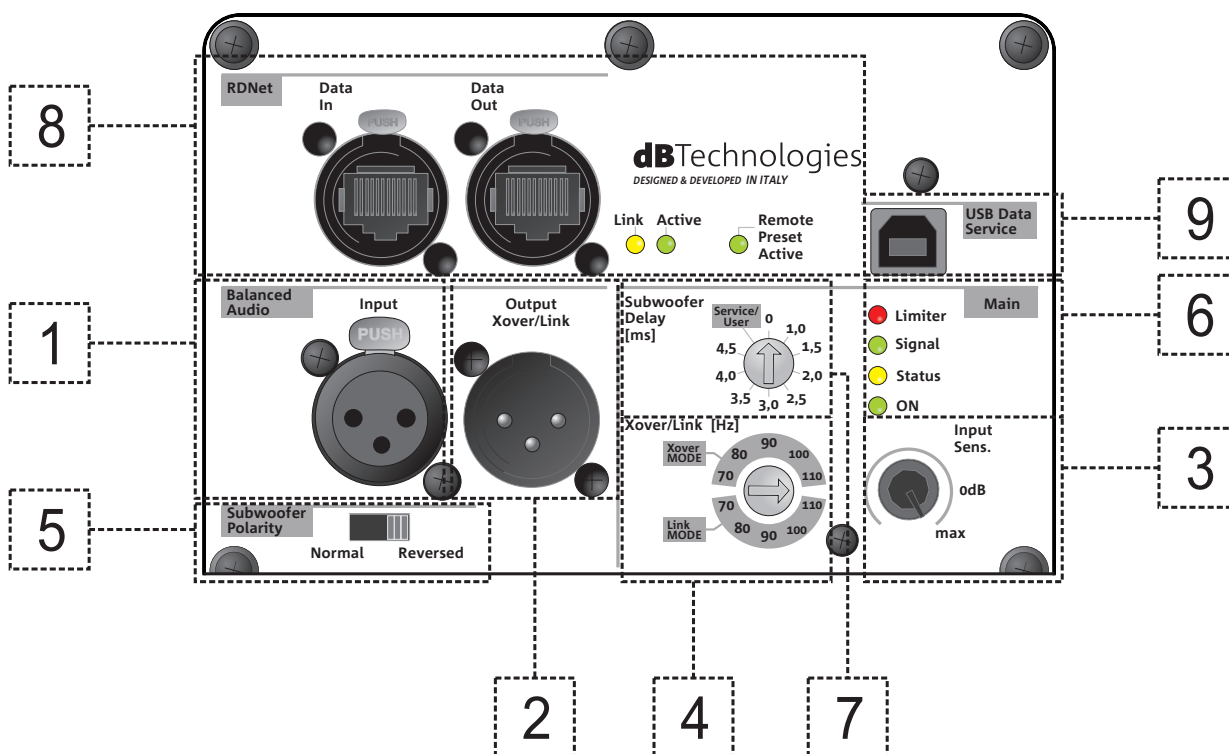

1. ENTRÉE

Connecteur de l'entrée, de type XLR (symétrique). Pour les détails de la connexion, se référer à la section *CONNEXION DES ENTRÉES ET RELANCE AUDIO*.

2. SORTIE

Connecteur de la sortie, de type XLR (symétrique). Sélectionner la fréquence de coupure relative au mode Xover/Link dans la commande rotative correspondante. Pour les détails de la connexion, se référer à la section *CONNEXION DES ENTRÉES ET RELANCE AUDIO*.

3. Sensibilité Entrée

Commande rotative de réglage de la sensibilité d'entrée.

4. Xover/Link rotary

Sélecteur permettant de régler la fréquence de coupure selon le mode choisi (Link/Xover). Il intervient sur le signal relancé par les connecteurs *Output Xover/Link*

5. Sélecteur Subwoofer Polarity

Sélecteur permettant de régler la Polarité (Normal ou Reverse)

6. LED (Limiter, Signal/ON)

LED de signalisation. La LED Limiter s'allume lors de l'intervention du circuit de protection interne, Signal/ON signale l'allumage du subwoofer et la présence du signal audio à l'entrée.

SECTION D'ALIMENTATION

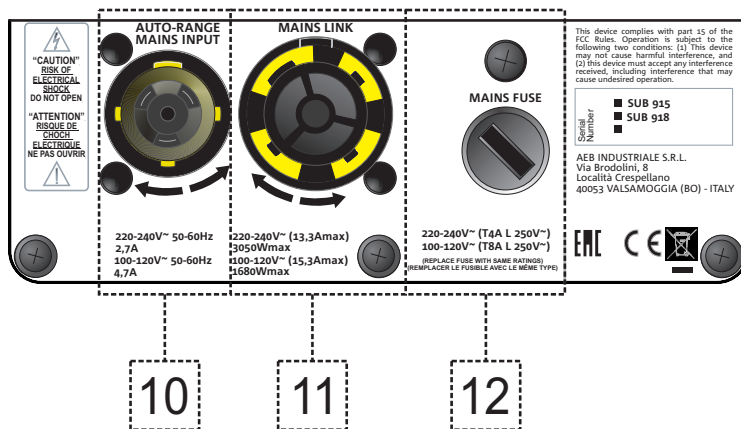
7. **Subwoofer Delay**

Commande rotative permettant de régler le retard (delay) en ms.

8. **Section RDNet avec LED de contrôle**

Section compatible avec les câbles de réseau avec connecteurs type etherCON/RJ45.

En particulier « Data in » doit être relié à des dispositifs comme RDNet Control 2 ou Control 8, « Data Out » est utilisé pour la relance du réseau à d'autres modules du line-array en configuration daisy-chain.

Les LED relatives au fonctionnement en réseau (RDNet) du module assurent une surveillance en temps réel. En particulier, « Link » allumé signale que le réseau RDNet est actif et a reconnu le dispositif, « Active » en mode clignotant, qu'il existe un trafic de données, « Remote Preset Active » que toutes les commandes locales sur le panneau amplificateur sont by-passées par la commande à distance RDNet.

9. **USB Data Service**

Connecteur USB pour la mise à jour du micrologiciel.

10. **ENTRÉE SECTEUR**

Compatible avec le connecteur powerCON TRUE1®.

11. **MAINS LINK**

Compatible avec connecteur type powerCON TRUE1® pour la relance de l'alimentation à d'autres modules. Pour savoir le nombre maximum de modules pouvant être connectés dans un système relancé, consulter la section [SPÉCIFICATIONS TECHNIQUES](#).

12. **MAINS FUSE**

Logement pour le fusible de réseau

2. PREMIER ALLUMAGE

L'emballage du subwoofer SUB 915 / SUB 918 contient :

- subwoofer 915 ou bien subwoofer 918
- câble d'alimentation POWERCON TRUE1
- quick start et la documentation papier de garantie

CONFIGURATION ET OPTIMISATION

Une fois le connecteur powerCON TRUE1®, inséré et tourné, branché à l'alimentation secteur, le subwoofer s'allume.

Pour une utilisation optimale du subwoofer dans certaines configurations spécifiques, l'utilisateur dispose sur le panneau de contrôle de :

- Xover/Link [Hz] :
 1. Link (le signal présent aux sorties OUTPUTS est celui appliqué au woofer)
 2. Xover (le signal présent aux sorties OUTPUTS est filtré selon une fréquence de crossover de 120 Hz, pour la relance à l'enceinte, comme par exemple B-HYPE et OPERA)
- Subwoofer Polarity :
 1. Normal (Polarité normale du signal audio)
 2. Reverse (Polarité inversée, option utile lors de l'optimisation du front d'onde par inversion de la phase de l'onde acoustique)
- Subwoofer Delay :

Il est possible de sélectionner le delay applicable à plusieurs configurations, selon les indications de la sérigraphie.

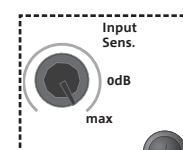
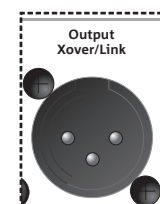
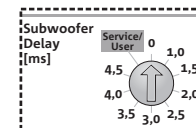
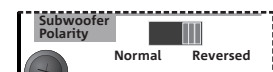
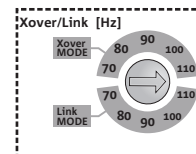

Avant l'allumage, il est conseillé de positionner le sélecteur de niveau Sensibilité Entrée sur 0 dB

CONNEXION DES ENTRÉES ET RELANCE AUDIO

2 figures d'exemples sont reportées à titre purement indicatif

En cas de connexion entre subwoofer et enceinte :

1. Relier la sortie du mélangeur au connecteur d'entrée du subwoofer
2. Relier le connecteur de sortie du subwoofer à l'entrée de l'enceinte.
3. Positionner OUTPUT XOVER/LINK [4] du subwoofer sur XOVER, afin de relancer à l'enceinte un signal avec fréquence de crossover sélectionnable par la commande rotative Xover/Link [Hz]

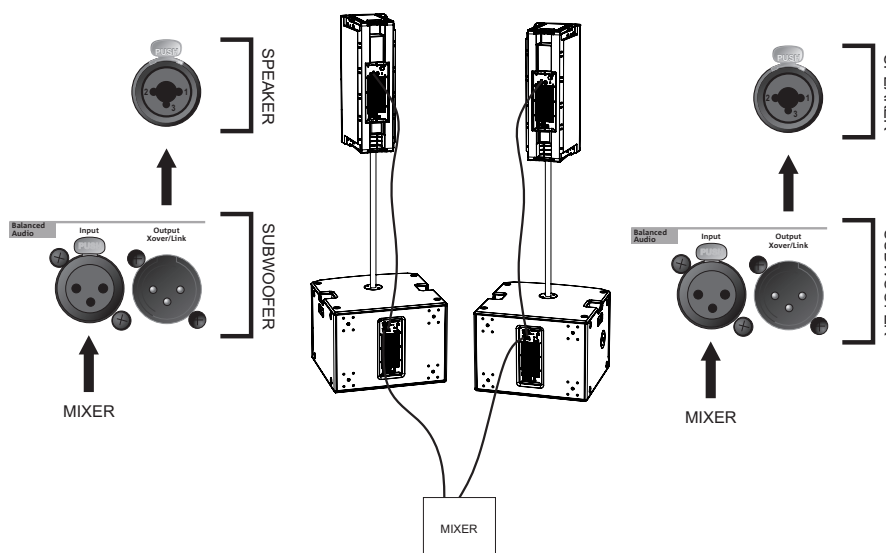
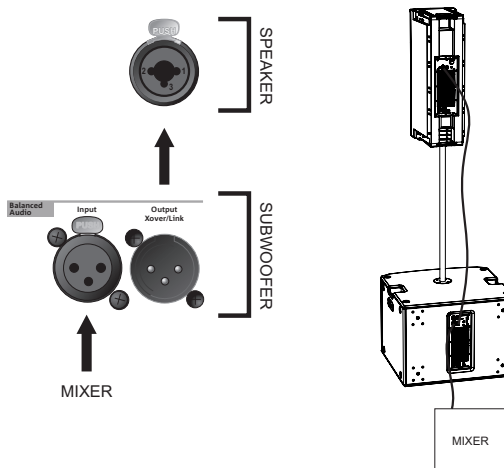

* Balanced

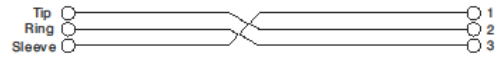
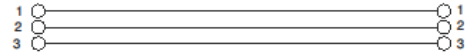
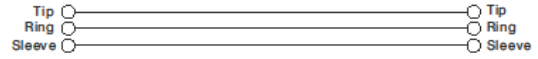
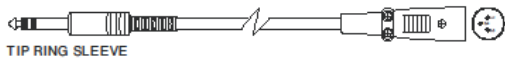
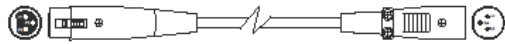
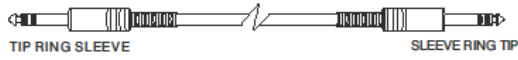

* Unbalanced

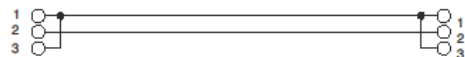
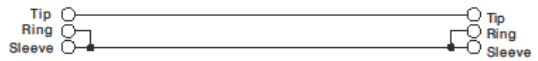
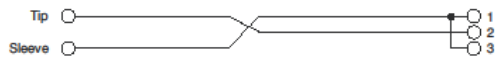
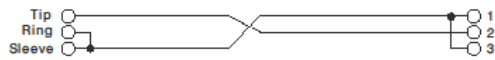
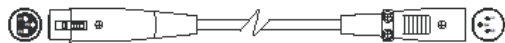
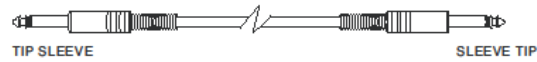
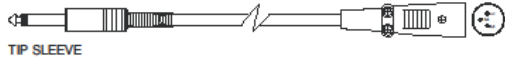
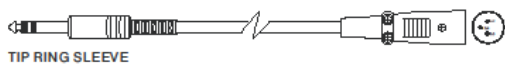

3. EXEMPLES D'UTILISATION



- Toute autre installation différente de celles ici décrites ne sera pas admise.
- Il est toujours interdit d'utiliser les poignées du subwoofer pour le suspendre
- Toujours vérifier que son positionnement soit stable et que l'installation ne comporte pas de risques aux personnes, animaux ou objets.

UTILISATION AU SOL

Il est possible d'utiliser des subwoofers 915 et 918 directement au sol.

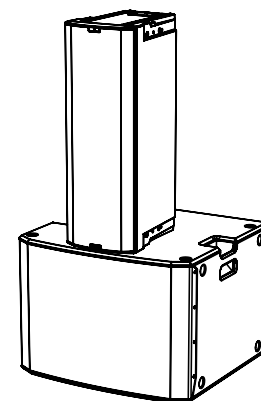

UTILISATION AVEC ENCEINTE EN STACK

Il est possible d'utiliser une enceinte installée directement sur le subwoofer 915 ou 918 au moyen du mini-poteau de 35 mm de diamètre DS2-S (ex. série : INGENIA, B-HYPE, OPERA).

Une fixation supplémentaire est requise.

UTILISATION SUR SUBWOOFER AVEC POTEAU TÉLESCOPIQUE

Il est possible d'utiliser une seule enceinte installée sur poteau de 35 mm de diamètre. L'accessoire de référence est DS-2 (poteau télescopique).

Une fixation supplémentaire est requise.

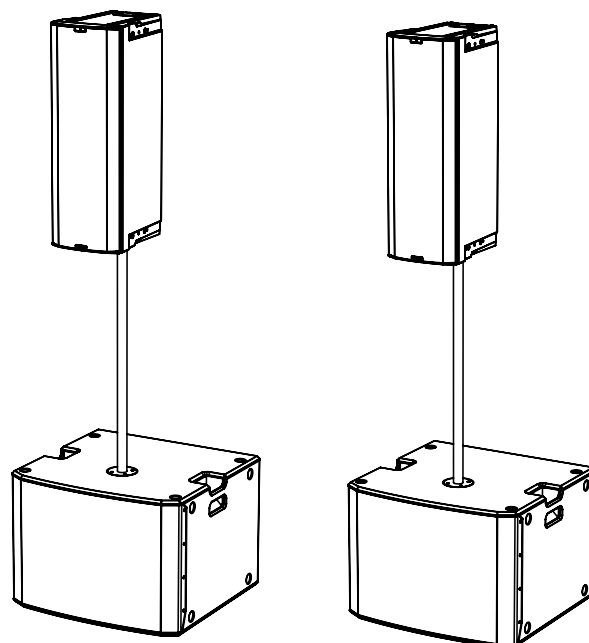

4. DÉPANNAGE

Le subwoofer ne s'allume pas :

1. Vérifier la correcte alimentation en amont du système.
2. Vérifiez que le cordon d'alimentation est correctement inséré.

Le subwoofer s'allume mais n'émet aucun son :

1. Vérifier que le raccordement à l'entrée du signal audio a été correctement effectué.
2. Vérifier que les câbles utilisés ne sont pas endommagés.
3. Vérifier que le mélangeur ou la source sonore est activé/e et montre clairement la présence du signal de sortie.
4. Vérifier le niveau général au moyen du contrôle « Sensibilité Entrée ».

L'enceinte émet un son inadéquat :

1. Vérifier que les câbles utilisés ne sont pas endommagés ; si nécessaire, les remplacer (un câble endommagé peut entraîner la perte ou l'altération du signal).
2. Vérifier que les réglages sur le panneau de contrôle sont correctement configurés.

5. SPÉCIFICATIONS TECHNIQUES

INFORMATIONS GÉNÉRALES

Type :	Subwoofer actif
--------	-----------------

DONNÉES ACOUSTIQUES

Réponse en fréquence [-10dB] :	45 - Cut freq Hz (SUB 915) / 42 -Cut Freq Hz (SUB 918)
Max SPL (1m) :	133 dB (SUB 915) / 134 dB (SUB 918)
LF :	15" (SUB 915) / 18" (SUB 918)
LF voice coil :	4"
Fréquence de crossover :	Variable (70 Hz - 80 Hz - 90 Hz - 100 Hz - 110 Hz)

AMPLIFICATEUR

Type :	DIGIPRO G3
Classe d'amplification	Classe D
Alimentation	PowerCON TRUE1
Puissance d'amplification RMS :	900 W

PROCESSEUR

Contrôleur interne :	DSP 28/56 bit
Limiter :	Peak, RMS, Thermique

INTERFACE UTILISATEUR

Commandes :	Delay, Xover/Link, Polarity, Sensitivity
-------------	--

ENTRÉES ET SORTIES

Entrées :	2 x XLR Balanced Inputs
Sorties :	2x XLR Balanced Outputs

SPÉCIFICATIONS D'ALIMENTATION (ABSORPTION / INSTALLATION)

Absorption à 1/8 de la puissance en conditions moyennes d'utilisation (*) :	1,2 A (220-240V~) - 2 A (110-120V~)
Absorption à 1/3 de la puissance en conditions maximales d'utilisation (**) :	2,7 A (220-240V~) - 4,7 A (110-120V~)
Absorption avec enceinte allumée en absence de signal (idle) :	21 W
Courant d'appel (inrush) :	21.04 A

* **REMARQUE POUR L'INSTALLATEUR** : Les valeurs se réfèrent à 1/8 de la puissance, dans des conditions moyennes de fonctionnement (programme de musique avec clipping rare ou absent). Il est conseillé pour tout type de configuration de considérer les valeurs minimales de dimensionnement.

** **REMARQUE POUR L'INSTALLATEUR** : Les valeurs se réfèrent à 1/3 de la puissance, dans des conditions lourdes de fonctionnement (programme de musique avec clipping fréquent et intervention du limiter). Il est conseillé d'effectuer le dimensionnement selon ces valeurs en cas d'installations et tours professionnels.

DIMENSIONS

Matériau :	Bois à couches multiples (avec peinture de protection noire)
Grille :	Usinage CNC
Poignées :	2, latérales
Installation sur poteau :	Oui, 36 mm (prédisposition : M20)
Largeur :	620 mm (SUB 915) 720 mm (SUB 918)
Hauteur :	457 mm (SUB 915) 530 mm (SUB 918)
Profondeur :	620 mm (SUB 915) 690 mm (SUB 918)
Poids :	34.8 kg (SUB 915) 41.8 kg (SUB 918)

Les caractéristiques, les spécifications et l'aspect des produits sont sujets à changement sans préavis. dBTechnologies se réserve le droit d'apporter des modifications ou des améliorations de design ou de fabrication, sans obligation de modifier ou d'améliorer également les produits déjà réalisés.



A.E.B. Industriale Srl
Via Brodolini, 8
Località Crespellano
40053 VALSAMOGGIA
BOLOGNE (ITALIE)

Tél. +39 051 969870
Fax +39 051 969725

www.dbtechnologies.com
info@dbtechnologies-aeb.com

ÍNDICE

1. INFORMACIÓN GENERAL.....	61
¡BIENVENIDOS!	61
INTRODUCCIÓN	61
REFERENCIAS PARA EL USUARIO.....	61
CARACTERÍSTICAS MECÁNICAS Y DEL SONIDO	62
<i>DIMENSIONES</i>	62
CARACTERÍSTICAS DE LA SECCIÓN DE AMPLIFICACIÓN Y CONTROL	63
<i>SECCIÓN DE ENTRADAS, SALIDAS Y CONTROL</i>	64
<i>SECCIÓN DE ALIMENTACIÓN</i>	65
2. PRIMER ENCENDIDO	66
<i>CONEXIÓN DE LAS ENTRADAS Y PUENTE AUDIO</i>	67
3. EJEMPLOS DE USO	69
USO EN EL SUELO	69
USO CON ALTAVOCES EN STACK	69
USO EN SUBWOOFER CON POSTE TELESCÓPICO	69
4. RESOLUCIÓN DE PROBLEMAS.....	70
5. ESPECIFICACIONES TÉCNICAS	71
<i>GENERAL</i>	71
<i>DATOS ACÚSTICOS</i>	71
<i>AMPLIFICADOR</i>	71
<i>PROCESADOR</i>	72
<i>INTERFAZ USUARIO</i>	72
<i>ENTRADAS Y SALIDAS</i>	72
<i>ESPECIFICACIONES DE ALIMENTACIÓN (ABSORCIÓN / INSTALACIÓN)</i>	72
<i>DIMENSIONES</i>	73

1. INFORMACIÓN GENERAL

¡BIENVENIDOS!

¡Gracias por adquirir este producto diseñado y desarrollado en Italia por dBTechnologies! Este subwoofer activo, versátil y ergonómico, es el resultado de una larga experiencia en el ámbito del refuerzo de sonido, con el uso de soluciones optimizadas en términos de sonido y electrónica, además de una atenta elección de los materiales.

INTRODUCCIÓN

Los nuevos subwoofers de la serie SUB 900 están equipados con un woofer de 15" (SUB 915) y un woofer de 18" (SUB 918) respectivamente. El diseño preciso y la optimización acústica permiten prestaciones de alta calidad en un producto de dimensiones reducidas. La elevada ergonomía y manejabilidad de los gabinetes permiten su fácil transporte.

Las características principales de SUB 915 y SUB 918 son:

- un proyecto ergonómico, compacto y versátil, para contextos interiores y para el aire libre
- gabinete de madera para optimizar las prestaciones acústicas, con superficie externa resistente para uso interior y al aire libre
- amplificador digital fiable y silencioso
- controles del DSP específicos, con selección de Polaridad, Delay, Xover, Sensitivity

REFERENCIAS PARA EL USUARIO

Para aprovechar al máximo el subwoofer recomendamos:

- leer la guía de consulta rápida suministrada con el producto y todas las secciones de este manual de uso, y guardarla durante toda la vida útil del producto.
- registrar el producto en la página web <http://www.dbtechnologies.com> en la sección "[SOPORTE TÉCNICO](#)".
- guardar prueba de compra y GARANTÍA (Manual de uso "sección 2").

CARACTERÍSTICAS MECÁNICAS Y DEL SONIDO

DIMENSIONES

Las dimensiones del SUB 915 y S918 son:

- SUB 915: 620 x 457 x 620 (mm)
- SUB 918: 720 x 530 x 690 (mm)

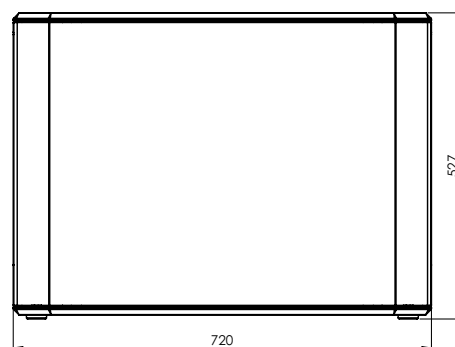
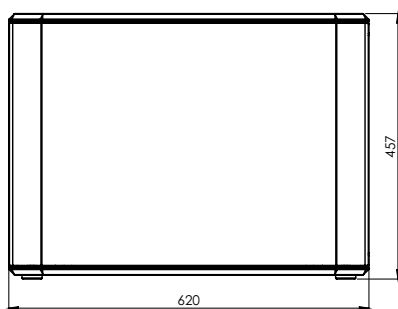
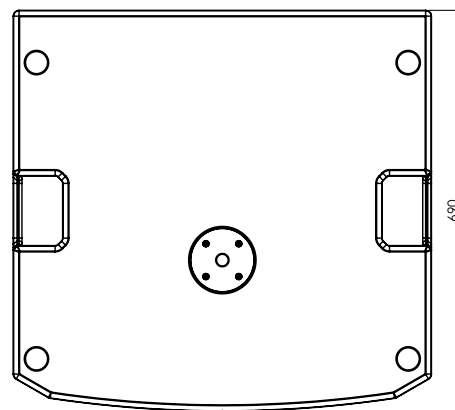
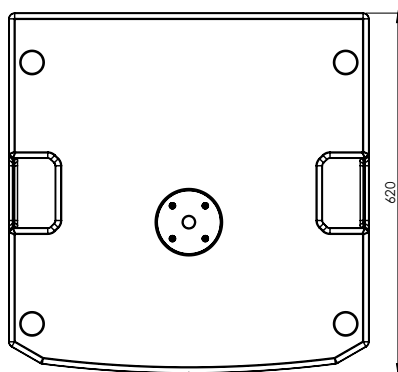

CARACTERÍSTICAS DE LA SECCIÓN DE AMPLIFICACIÓN Y CONTROL

El amplificador Digipro G3 es el corazón de los SUB 915 y SUB 918.

El sistema es silencioso y su control se basa en un DSP específico que controla varios parámetros.

La potencia de amplificación sonora es de 900 W RMS.

El panel del amplificador cuenta con:

- Sección de Entradas, Salidas y Control
- Sección de Alimentación



¡ATENCIÓN!

- No intentar abrir el amplificador de ninguna manera.
- En caso de excesivo sobrecalentamiento, el volumen del sonido se reduce gradualmente hasta lograr la estabilización térmica del módulo. El nivel se restablece automáticamente al alcanzar la temperatura de funcionamiento correcta.
- En caso de funcionamiento incorrecto, quitar inmediatamente la alimentación desconectando el módulo de la red y contactar con un técnico autorizado.



¡ATENCIÓN!

- Nunca quitar la rejilla frontal de protección del producto. Para evitar el riesgo de descarga eléctrica, en caso de daños accidentales o si se debe sustituir la rejilla de protección (que se debe efectuar en el servicio de asistencia), desconectar inmediatamente la alimentación. No conectar nunca la fuente de alimentación de la red eléctrica cuando la rejilla no se encuentre colocada.

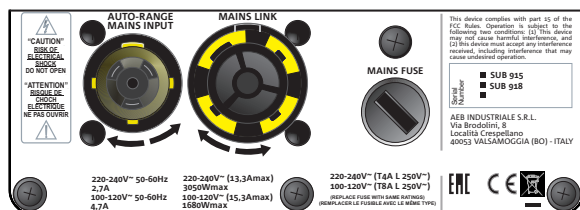
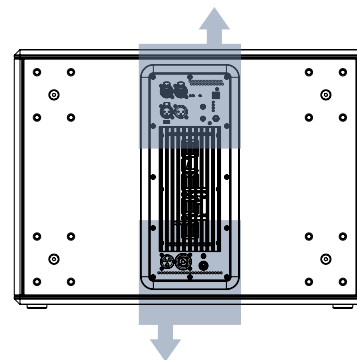
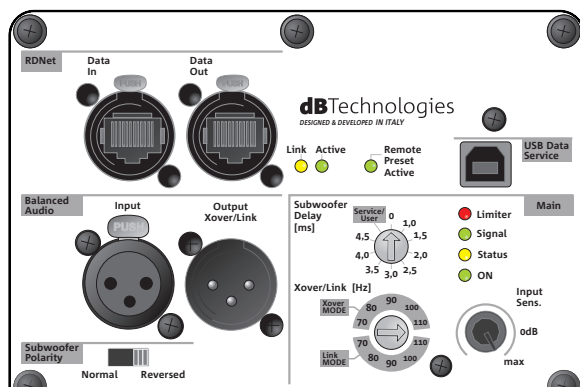

SECCIÓN DE ENTRADAS, SALIDAS Y CONTROL

SECCIÓN DE ALIMENTACIÓN

SECCIÓN DE ENTRADAS, SALIDAS Y CONTROL

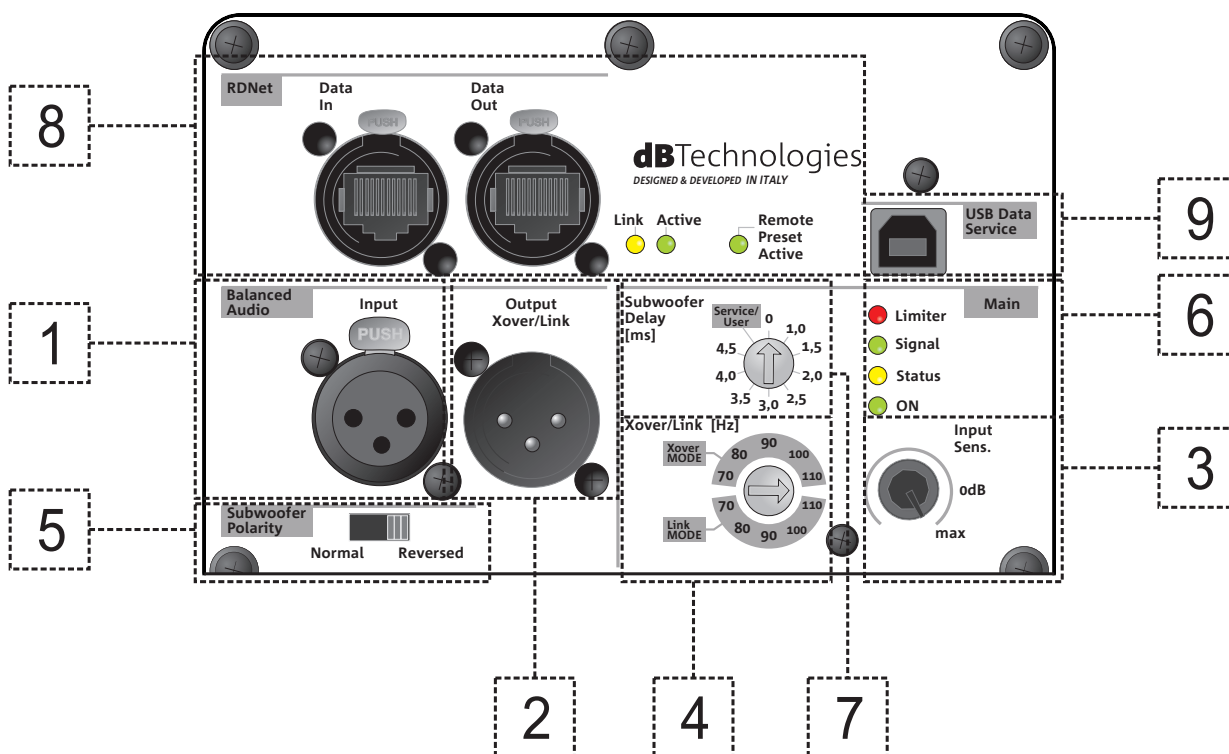

1. ENTRADA

Conector de la entrada, de tipo XLR (balanceado). Para los detalles de conexión, ver la sección *CONEXIÓN DE LAS ENTRADAS Y PUENTE AUDIO*.

2. SALIDA

Conectores de salida, de tipo XLR (balanceado). Seleccionar la frecuencia de corte relativa a la modalidad Xover/Link en el rotary correspondiente. Para los detalles de conexión, ver la sección *CONEXIÓN DE LAS ENTRADAS Y PUENTE AUDIO*.

3. Entrada Sensitivity

Rotary de regulación de la sensibilidad de entrada.

4. Xover/Link rotary

Selector que permite programar la frecuencia de corte según la modalidad seleccionada (Link/Xover). Actúa en la señal lanzada por los conectores *Output Xover/Link*

5. Selector Subwoofer Polarity

Selector que permite intervenir en la Polaridad (Normal o Reverse)

6. LED (Limiter, Signal/ON)

Led de señalización. El led Limiter se enciende en caso de que intervenga el circuito de protección interna, Signal/ON detecta el encendido del subwoofer y la presencia de señal audio de entrada.

SECCIÓN DE ALIMENTACIÓN

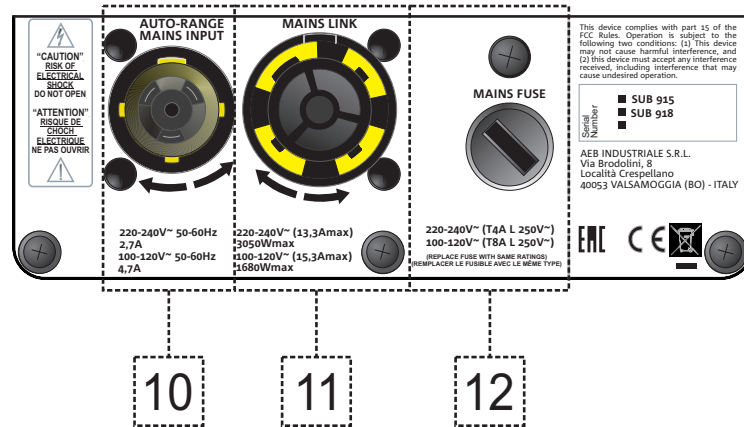

7. Subwoofer Delay

Rotary que permite programar el retraso (delay) en ms.

8. Sección RDNet con LED de control

Sección compatible con cables de red que cuentan con conectores etherCON/RJ45.

En particular “Data in” debe estar conectado a dispositivos como RDNet Control 2 o Control 8, “Data Out” viene utilizado para el puente de la red a otros módulos del line-array en configuración daisy-chain.

Los led relativos al funcionamiento en red (RDNet) del módulo aseguran una monitorización en tiempo real.

En particular, “Link” encendido indica que la red RDNet está activa y que ha reconocido el dispositivo, “Active” destellante indica que existe tráfico de datos, “Remote Preset Active” que todos los controles locales en el panel amplificador son superados por el control remoto RDNet.

9. USB Data Service

Conector USB para la actualización firmware.

10. MAINS INPUT

Compatible con conector powerCON TRUE1®.

11. MAINS LINK

Compatible con conector tipo powerCON TRUE1® para el puente de alimentación a los demás módulos.

Para conocer el número máximo de módulos que pueden conectarse en un sistema transmitido, consultar la sección [ESPECIFICACIONES TÉCNICAS](#).

12. MAINS FUSE

Alojamiento del fusible de red

2. PRIMER ENCENDIDO

El embalaje del subwoofer SUB 915 / SUB 918 contiene:

- subwoofer 915 o subwoofer 918
- cable de alimentación POWERCON TRUE1
- guía de consulta rápida y documentación de la garantía en papel

CONFIGURACIÓN Y OPTIMIZACIÓN

Se ha introducido y girado el conector powerCON TRUE1®, conectado a la alimentación de red, el subwoofer se enciende.

Para optimizar el uso del subwoofer para algunas particulares configuraciones, el usuario tiene a disposición en el panel de control:

- Xover/Link [Hz]:
 1. Link (la señal presente en las salidas OUTPUTS es la aplicada al woofer)
 2. Xover (la señal presente en las salidas OUTPUTS es filtrada con frecuencia de crossover de 120 Hz, para el puente de altavoces, como por ejemplo B-HYPE y OPERA)
- Subwoofer Polarity:
 1. Normal (Polaridad normal de la señal audio)
 2. Reverse (Polaridad invertida, opción necesaria para optimizar el frente de onda invirtiendo la fase de la onda acústica)
- Subwoofer Delay:

Es posible seleccionar el delay aplicable para varias configuraciones, según las indicaciones de la serigrafía.

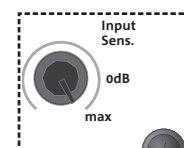
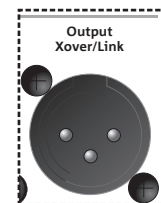
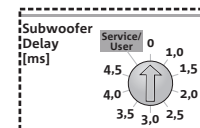
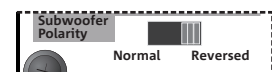
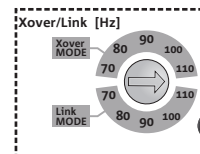

Antes del encendido, se recomienda colocar el selector de nivel Entrada Sensitivity en 0 dB

CONEXIÓN DE LAS ENTRADAS Y PUENTE AUDIO

Las 2 figuras presentes son solo un ejemplo

En caso de conexión entre subwoofer y altavoz:

1. conectar la salida de la mezcladora al conector de entrada del subwoofer;
2. conectar el conector de salida del subwoofer a la entrada del altavoz;
3. colocar la SALIDA XOVER/LINK [4] del subwoofer en XOVER, para transmitir al altavoz una señal con frecuencia de crossover que se puede seleccionar con el rotary Xover/Link [Hz]

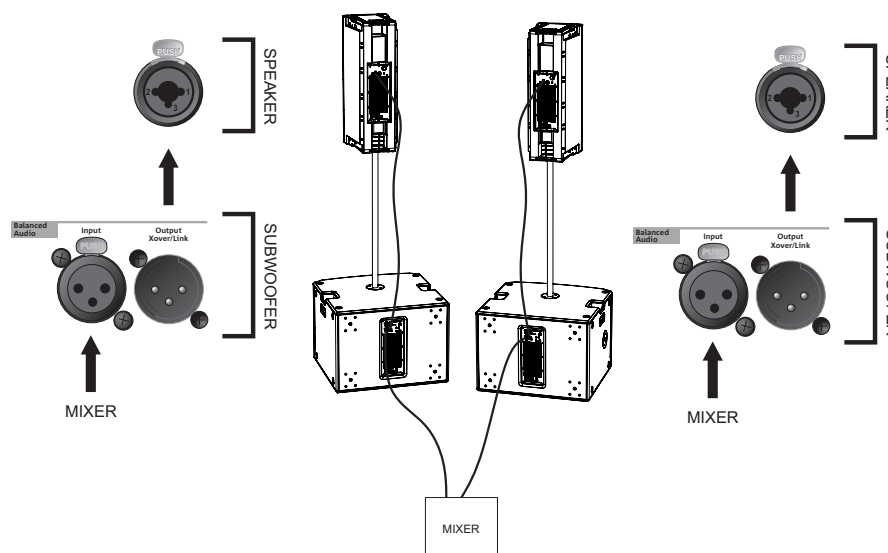
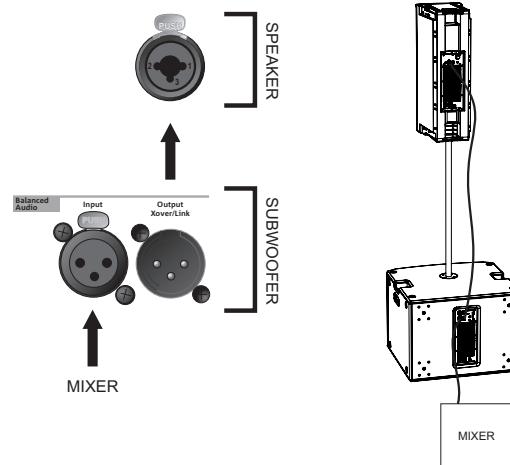

• **Balanced**

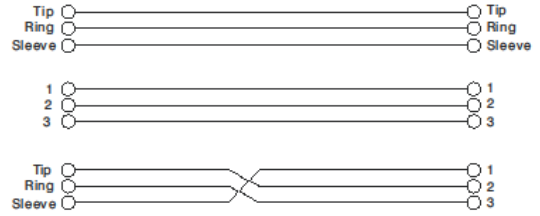
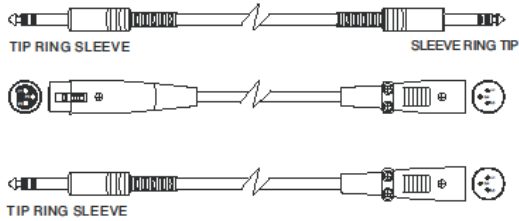

• **Unbalanced**

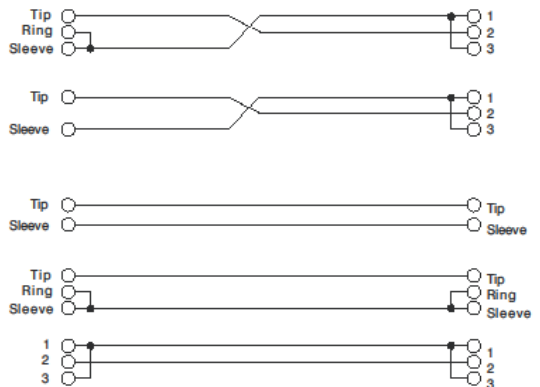
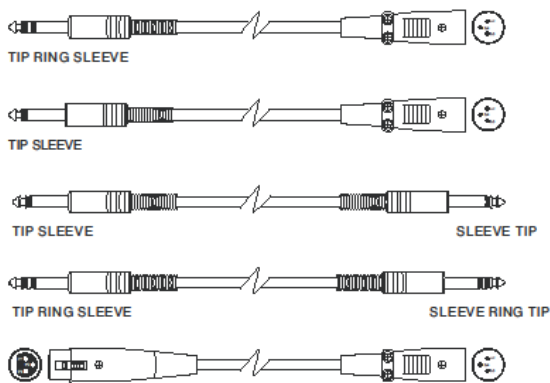

3. EJEMPLOS DE USO



- No se admiten tipos de instalación diferentes de los ilustrados aquí.
- No usar en ningún caso las asas del subwoofer para colgarlo
- Comprobar siempre que el posicionamiento sea estable y que la instalación no represente una fuente de peligro para personas, animales o cosas.

USO EN EL SUELO

Es posible el uso de los subwoofers 915 y 918 directamente en el suelo.

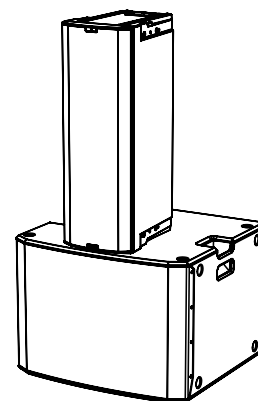

USO CON ALTAVOCES EN STACK

Es posible el uso de un altavoz montado directamente sobre el subwoofer 915 o 918 mediante el miniposte de 35 mm diámetro DS2-S (por ej. serie: INGENIA, B-HYPE, OPERA).

Se requiere una fijación adicional

USO EN SUBWOOFER CON POSTE TELESCÓPICO

Es posible usar un solo altavoz montado en un poste de 35 mm de diámetro. El accesorio de referencia es DS-2 (poste telescópico).

Se requiere una fijación adicional

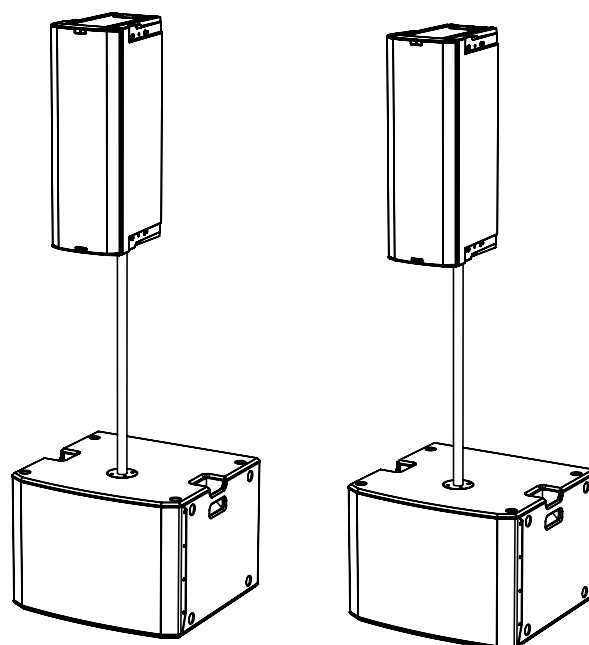

4. RESOLUCIÓN DE PROBLEMAS

El subwoofer no se enciende:

1. Comprobar la presencia correcta de la alimentación general del sistema.
2. Comprobar que el cable de alimentación esté conectado correctamente.

El subwoofer se enciende, pero no emite sonidos:

1. Comprobar que la conexión de entrada de la señal de audio se haya efectuado correctamente.
2. Comprobar que los cables utilizados no estén dañados.
3. Comprobar que la mezcladora o la fuente de audio esté encendida y muestre claramente la presencia de una señal de salida.
4. Comprobar el nivel general mediante el control "Entrada Sensitivity".

El altavoz emite un sonido no adecuado:

1. Comprobar que los cables utilizados no estén dañados, y sustituirlos si es necesario (un cable dañado puede causar una pérdida o alteración de la señal).
2. Comprobar que la configuración del panel de control se haya ajustado correctamente.

5. ESPECIFICACIONES TÉCNICAS

GENERAL

Tipo:	Subwoofer activo
-------	------------------

DATOS ACÚSTICOS

Respuesta en frecuencia [-10 dB]:	45 - Cut freq Hz (SUB 915) / 42 -Cut Frec Hz (SUB 918)
Máx. SPL (1 m):	133 dB (SUB 915) / 134 dB (SUB 918)
LF:	15" (SUB 915) / 18" (SUB 918)
Bobina de voz LF:	4"
Frecuencia de crossover:	Variable (70 Hz - 80 Hz - 90 Hz - 100 Hz - 110 Hz)

AMPLIFICADOR

Tipo:	DIGIPRO G3
Clase de amplificación	Clase D
Alimentación	PowerCON TRUE1
Potencia de amplificación RMS:	900 W

PROCESADOR

Controlador interior:	DSP 28/56 bits
Limitador:	Peak, RMS, Térmico

INTERFAZ USUARIO

Controles:	Delay, Xover/Link, Polarity, Sensitivity
------------	--

ENTRADAS Y SALIDAS

Entradas:	2 x XLR Balanced Inputs
Salidas:	2x XLR Balanced Outputs

ESPECIFICACIONES DE ALIMENTACIÓN (ABSORCIÓN / INSTALACIÓN)

Absorción a 1/8 de la potencia en condiciones medias de uso (*):	1.2 A (220-240V~) - 2 A (110-120V~)
Absorción a 1/3 de la potencia en condiciones máximas de uso (**):	2.7 A (220-240V~) - 4.7 A (110-120V~)
Absorción con altavoz encendido en ausencia de señal (idle):	21 W
Corriente de inrush:	21.04 A

* **NOTA PARA EL INSTALADOR:** Valores que se refieren a 1/8 de la potencia, en condiciones medias de funcionamiento (programa musical con clipping raro o ausente). Para cualquier tipo de configuración, se recomienda considerar los valores mínimos de dimensionamiento.

** **NOTA PARA EL INSTALADOR:** Valores que se refieren a 1/3 de la potencia, en condiciones pesadas de funcionamiento (programa musical con frecuente clipping e intervención del limitador). Se recomienda el dimensionamiento según estos valores en caso de instalaciones y tours profesionales.

DIMENSIONES

Material:	Madera de varias capas (con pintura de protección negra)
Rejilla:	Elaboración CNC
Asas:	2, laterales
Montaje en poste:	Sí, 36 mm (predisposición: M20)
Ancho:	620 mm (SUB 915) 720 mm (SUB 918)
Altura:	457 mm (SUB 915) 530 mm (SUB 918)
Profundidad:	620 mm (SUB 915) 690 mm (SUB 918)
Peso:	34.8 kg (SUB 915) 41.8 kg (SUB 918)

Características, especificaciones y aspecto de los productos pueden cambiar sin previo aviso. dBTechnologies se reserva el derecho de modificar o mejorar el diseño o la fabricación sin asumir la obligación de modificar o mejorar también los productos realizados anteriormente.



A.E.B. Industriale Srl
Via Brodolini, 8
Località Crespellano
40053 VALSAMOGGIA
BOLOGNA (ITALIA)

Tel +39 051 969870
Fax +39 051 969725

www.dbtechnologies.com
info@dbtechnologies-aeb.com